

I.I.D.



Memorandum Department of Planning & Public Works

To: Planning and Public Works Committee

From: Shawn Seymour, Senior Planner

Date: 09/19/2011

RE: P.Z. 04-2011 Arbors at Wild Horse Creek (17560 Wild Horse Creek, LLC.): A request for a zoning map amendment from a "E1-AC" Estate District (one acre) to a "PUD" Planned Unit Development of 23.422 acres in size and located on the south side of Wild Horse Creek Road west of its intersection of Long Road and east of its intersection with Wild Horse Parkway Drive (18V330046).

Summary

McBride & Sons are requesting a zoning map amendment from the City of Chesterfield, to change the zoning of a tract of land currently zoned "E-1 AC" Estate District (one acre) to "PUD" Planned Unit Development. A Public Hearing was held on August 25, 2011 and at that time the Planning Commission and City Staff did not have any outstanding issues.

The purpose of this zoning map amendment is to obtain PUD zoning for the site to ultimately develop this property as a twenty-two (22) unit single-family residential subdivision. As the property is topographically changing, it would be very difficult to develop and subdivide this site into twenty-two (22) one (1) acre lots as required and permitted under the existing E-1 AC zoning. Therefore the petitioners have proposed utilizing PUD zoning, in order to gain flexibility to the dimensional requirements of the zoning ordinance. The petitioners are requesting to develop and subdivide this property into twenty-two (22) single family lots with a minimum lot size of 24,000 sf., slightly larger than one-half acre. Although smaller than the existing E-1 AC zoning would permit, this lot size is comparable and similar to those lots found in neighboring residential subdivisions. In the process the petitioners propose to maintain forty-nine (49) percent of the existing tree canopy and provide thirty-two (32) percent openspace, which provides for seven and one-half (7.5) acres of common ground. This would not be possible if the site were to be developed and subdivided into twenty-two (22) one (1) acre lots, per the E-1 AC zoning requirements.

At the September 12, 2011 meeting of the Planning Commission this petition for a zoning map amendment was further reviewed. One (1) issue was raised during this meeting; that being the City's ability to ensure preservation of the existing tree canopy located on private property that is shown on the Preliminary Plan. It was noted by Staff, that the Preliminary Plan and all subsequent required plans and plats will note these areas are "*Greenspace Preservation Area*". Per City Ordinance, this term is defined as, *an area designated within a proposed development within which all existing healthy trees, vegetation, stream corridors, soil grade and any existing or additional landscape plantings are to be permanently protected and preserved. No structures or paving are permitted in a*

greenspace preservation area. Therefore, the City has the ability to enforce the requirement of preservation of these areas as it may enforce any other ordinance in the City. Further, it was noted that this area of the site, specifically lots 16, 17, & 18 are located on such challenging topography, that it would extremely difficult to construct anything in this area of the site. As shown in the section profile below, from the highest point of lots 16, 17, & 18 the topography slopes downward slightly less than twenty (20) feet.

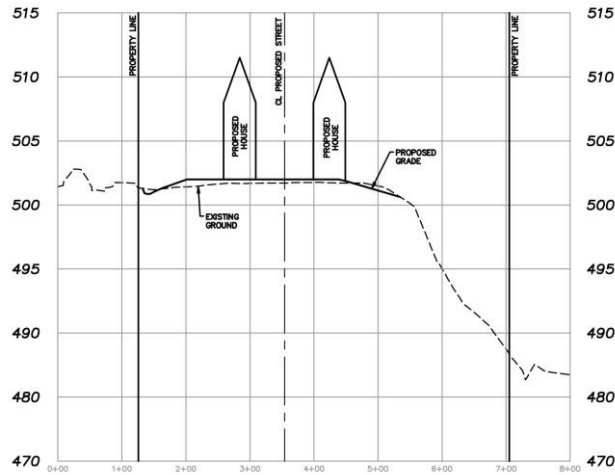

Extensive grading would be required to improve this area and would require the submittal of Improvement Plans and the granting of a Grading Permit by the City. Also, the petitioner has agreement to provide a notice to all purchasers of property within this development, that where greenspace preservation areas are located on private property, that no improvements may be made and that compliance with City Ordinance will be required. Finally, lots shown on the Preliminary Plan that include areas of greenspace preservation will be platted as such to note the same and further laminating the requirement of preservation.

On September 12, 2011, the Planning Commission voted to recommend approval by a count of 7 – 0 for the change of zoning request.

Attached please find a copy of Staff's report, the Attachment A, and the Preliminary Plan.

Respectfully submitted,

Shawn P. Seymour, AICP
Senior Planner

CC: Michael G. Herring, City Administrator
Rob Heggie, City Attorney
Michael O. Geisel, Director of Planning & Public Works
Aimee Nassif, Director of Planning & Development Services



VIII.B

690 Chesterfield Pkwy W • Chesterfield MO 63017-0760
Phone: 636-537-4000 • Fax 636-537-4798 • www.chesterfield.mo.us

Planning Commission Vote Report

Subject: Zoning Map Amendment Vote Report

Meeting Date: September 12, 2011

From: Shawn Seymour, AICP
Senior Planner

Location: On the south side of Wild Horse Creek Road west of its intersection with Long Road and east of its intersection with Wild Horse Parkway Drive (18V330046).

Petition: P.Z. 04-2011 Arbors at Wild Horse Creek (17560 Wild Horse Creek, LLC)

Proposal Summary

McBride & Sons are requesting a zoning map amendment from the City of Chesterfield, to change the zoning of a tract of land currently zoned “NU” Non-Urban District. The requested amendment would change the zoning to “PUD” Planned Unit Development and permit the property to be developed for single family residential purposes. The property was originally zoned “NU” Non-Urban District by St. Louis County and has been primarily used for agricultural purposes.

The petitioners are requesting to zone the property “PUD” Planned Unit Development as part of a two-step zoning process in order to obtain entitlements to develop this tract of land as a single family residential subdivision. The first step requires a change of zoning from the current “NU” district to “E-1 AC” Estate District (one acre) for the purpose of establishing a maximum density. This is being proposed by petition P.Z. 03-2011 Arbors at Wild Horse Creek. This petition, P.Z. 04-2011 Arbors at Wild Horse Creek, requests approval of a zoning map amendment from the proposed “E-1 AC” district to a “PUD” district for the purpose of modifying the development standards of the Zoning Ordinance of the City of Chesterfield.

Site Area History

St. Louis County zoned the subject site “NU” Non-Urban District in 1965. The property has been utilized for agricultural purposes throughout the duration of initial zoning to current.

In 2001 and 2002, the City of Chesterfield received several petitions for zoning map amendments for this site. All petitions were submitted with the goal of developing the site for residential purposes. P.Z. 08/09-2001 was a request for a zoning map amendment to the “E3” Estate Residence District (one-half acre) and a “PEU” Planned Environmental Unit. These petitions were subsequently deemed inactive post public hearing. P.Z. 33-2001 was a further attempt to obtain the “E3” zoning designation. This petition was deemed inactive prior to the scheduling of a public hearing. In 2002, petitions P.Z. 10-2002 and P.Z. 28-2002 were submitted in final attempts to obtain “E3” zoning entitlements, but were withdrawn and deemed inactive respectively. In all four petitions, the petitioner was unable to meet complete submittal requirements or was unable to meet staff’s review of minimum design standards.

Zoning Analysis

The property was zoned “NU” Non-Urban District by St. Louis County in 1965 and has been used for agricultural activities since that time. Adjacent properties to the north, west and south are developed as residential. To the east exists a church and an additional agricultural property. The residential developments in this area of Ward 4 contain a standard density of one (1) unit per acre. This has been accomplished both through minimum lots sizes of one (1) acre in some developments and the utilization of special procedures, not unlike PUD zoning, to subdivide lots into less than one (1) acre in size and maintaining significant amounts of undeveloped common ground.

The Arbors at Wild Horse is a proposed single family residential subdivision of 23 acres in size. The petitioners, McBride & Sons, wish to change the zoning of this property to permit the construction of twenty-two (22) homes. McBride & Sons has chosen to seek PUD zoning in order to develop lots of less than one (1) acre in size for the purpose of maintaining as much of the natural landscape and topography of the site as possible; while still being able to develop the twenty-two (22) homes as to complement the surrounding residential density. The proposed modifications from the City of Chesterfield Zoning Ordinance are detailed below.

	Min Lot Size	Front Yard Setback	Rear Yard Setback	Side Yard Setback
E-1 AC	1 AC or 43,560 sf	25 ft	25 ft	25 ft
Wildhorse Sub.	22,000 sf	25 ft	15 ft	12 ft
Arbors	24,000 sf	20 ft	25 ft*	10 ft

*The rear yard setback will vary throughout the proposed development. Lots 1 – 13 will have a fifty (50) foot rear yard setback to accommodate the fifty (50) foot landscaped buffer along the western edge of the development. Lots 14, 15, and 19 – 22 will have a

twenty-five (25) foot setback. Lots 16 – 18 will have a twenty-five (25) foot setback as modified and illustrated on the preliminary plan. This setback is as such due to the existing slopes and tree preservation area which is located adjacent to the rear of these lots.

In exchange for PUD zoning and these modifications, McBride & Sons offer the following.

1. Fifty (50) foot landscaped buffer along the western boundary of the site in place of the required thirty (30) foot buffer.
2. At minimum sixty (60) foot buffer along the eastern boundary of the site in place of the required thirty (30) foot buffer.
3. Tree canopy preservation of forty-nine (49) percent in place of the required thirty (30) percent.
4. Three (3) walking paths.

Surrounding Land Use and Zoning

The land use and zoning for the properties surrounding this parcel are as follows:

North: The properties to the north are single-family residences and are zoned “NU” Non-Urban District.

South: The adjacent properties to the south are single-family homes and are zoned “R1” Residence District.

East: The adjacent properties to the east are a church and an unimproved field used for agricultural purposes. Both properties are zoned “NU” Non-Urban District.

West: The properties located to the west are single-family residential and are zoned “R1” Residence District.

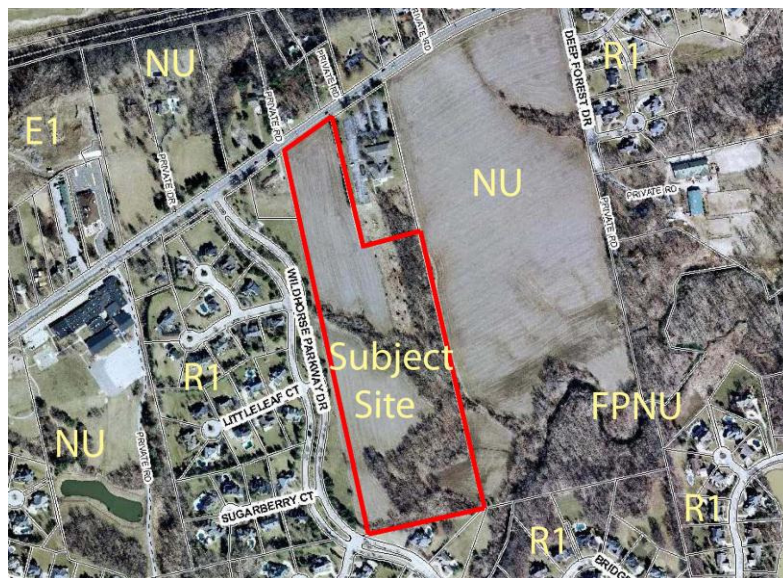



View looking SW at Site.



View looking SE at Site.



View looking east across site at creek.



View looking at south end of site.

Comprehensive Plan Analysis

The Comprehensive Plan Land Use Map depicts this property as Residential Single Family. As such, the proposed land use of a residential subdivision would be consistent with this Land Use Map designation.

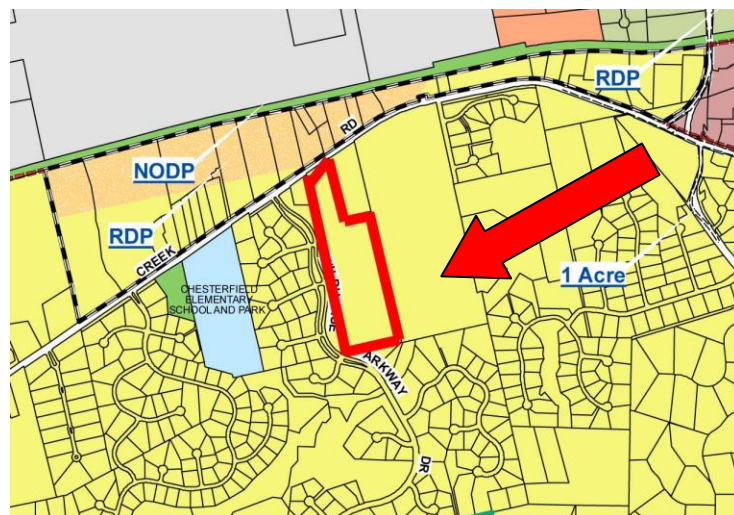

Issues

A Public Hearing was held on July 25, 2011. Staff had one (1) outstanding issue, that being obtaining comment letters from outside agencies. Since that time, staff has received all necessary letters and therefore this issue is closed.

The Planning Commission requested that language be added to the Attachment A to require that the Architectural Review Board review the elevations of the proposed single-family homes at the time of site plan review. The appropriate language has been added to the PUD Attachment A and this issue is also considered to be closed.

Request

Staff has reviewed the requested zoning map amendment by McBride & Sons as it pertains to the proposed development, the Arbors at Wild Horse Creek. The request for a zoning map amendment from an "E-1 AC" Estate District (one acre) to a "PUD" Planned Unit Development meets all requirements of the City of Chesterfield. Staff requests action on P.Z. 04-2011 Arbors at Wild Horse Creek (17560 Wild Horse Creek, LLC.).

ATTACHMENT A

All provisions of the City of Chesterfield City Code shall apply to this development except as specifically modified herein.

I. SPECIFIC CRITERIA

A. PERMITTED USES

1. The uses allowed in this PUD District shall be:
 - a. Dwellings, Single Family Detached

B. DENSITY REQUIREMENTS

1. The total number of single family residential density units shall not exceed twenty-two (22).

C. DEVELOPMENT STANDARDS

1. Minimum lot size for this development shall be 24,000 sf.
2. Setbacks shall be as shown on the Preliminary Plan and made a part of this Ordinance as Exhibit 1.
3. Maximum height of all structures shall be fifty (50) feet.

D. LANDSCAPE AND TREE REQUIREMENTS

1. The developer shall adhere to the Tree Preservation and Landscape Requirements of the City of Chesterfield Code.
2. A landscaped buffer shall be required around the entire perimeter of the PUD as follows.
 - a. Fifty (50) feet along the western boundary of the development.
 - b. Thirty (30) feet along the southern boundary of the development.

- c. Thirty (30) feet along the eastern boundary of the development.
- d. Thirty (30) feet along the northern boundary of the development.

3. A minimum of 30% open space shall be required for this PUD.

E. PARKING

The developer shall adhere to the Parking requirements of the City of Chesterfield Code.

F. ARCHITECTURAL

The developer shall adhere to the Architectural Review Standards of the City of Chesterfield Code. Elevations shall be reviewed by the Architectural Review Board at the time of Site Development Plan submittal.

G. SIGN REQUIREMENTS

Signs shall be permitted in accordance with the regulations of the City of Chesterfield Code.

H. LIGHT REQUIREMENTS

Provide a lighting plan and cut sheet in accordance with the City of Chesterfield Code.

I. ACCESS/ACCESS MANAGEMENT

Access to Wild Horse Creek Road shall be limited to one street approach. The street approach shall be as close to the east property line as practical and adequate sight distance shall be provided, as directed by the Department of Planning and Public Works and the Missouri Department of Transportation.

J. PUBLIC/PRIVATE ROAD IMPROVEMENTS, INCLUDING PEDESTRIAN CIRCULATION

- 1. Any request to install a gate at the entrance to this development must be approved by the City of Chesterfield **and the St. Louis County Department of Highways and Traffic and the**

Missouri Department of Transportation. No gate installation will be permitted on public right of way.

2. If a gate is installed on a street in this development, the streets within the development or that portion of the development that is gated shall be private and remain private forever.
3. All roadway and related improvements in each plat or phase of the development shall be constructed prior to issuance of building permits exceeding 60% for that plat or phase.
4. Provide a 5 foot wide sidewalk, conforming to ADA standards, along the Wild Horse Creek Road frontage of the site. The sidewalk shall connect to the sidewalk to be constructed with the adjacent development to the east and west. The sidewalk may be located within State right-of-way, if permitted by the Missouri Department of Transportation, or within a 6 foot wide sidewalk, maintenance and utility easement.
5. The Missouri Department of Transportation requires this property to provide right of way dedication across their entire property frontage for the future highway construction.
6. Provide a study on the proposed left turns to see if it warrants this development to construct a left turn lane.
7. Ingress and egress must conform to MoDOT's Access Management Guidelines and must be reviewed and approved by MoDOT. Any changes to the entrance geometrics and drainage design shall be in accordance with MoDOT standards and shall be reviewed and approved by MoDOT. Roadway improvements may be required to support the proposed development.
8. Any work within MoDOT's right of way will require a MoDOT permit.
9. The petitioner shall provide adequate detention and/or hydraulic calculations for review and approval of all stormwater that will encroach on MoDOT right of way.
10. All drainage detention storage facilities shall be placed outside of the standard governmental agencies planning and zoning setbacks, or fifteen (15) feet from the new or existing MoDOT right of way line, whichever is greater.

K. TRAFFIC STUDY (if applicable)

Provide a traffic study as directed by the City of Chesterfield and/or the Missouri Department of Transportation or St. Louis County Department of Highways and Traffic. The scope of the study shall include internal and external circulation and may be limited to site specific impacts, such as the need for additional lanes, entrance configuration, geometrics, sight distance, traffic signal modifications or other improvements required, as long as the density of the proposed development falls within the parameters of the City's traffic model. Should the density be other than the density assumed in the model, regional issues shall be addressed as directed by the City of Chesterfield.

L. POWER OF REVIEW

The Mayor or a Councilmember of the Ward in which a development is proposed may request that the Site Development Plan be reviewed and approved by the entire City Council. This request must be made no later than 24 hours before posting the agenda for the next City Council meeting after Planning Commission review and approval of the Site Development Plan. The City Council will then take appropriate action relative to the proposal.

M. STORMWATER

1. The site shall provide for the positive drainage of storm water and it shall be discharged at an adequate natural discharge point or connected to an adequate piped system.
2. Detention/retention and channel protection measures are to be provided in each watershed as required by the City of Chesterfield. The storm water management facilities shall be operational prior to paving of any driveways or parking areas in non-residential development or issuance of building permits exceeding sixty (60%) of approved dwelling units in each plat, watershed or phase of residential developments or as otherwise directed by MSD. The location and types of storm water management facilities shall be identified on the Site Development Plan(s).

N. SANITARY SEWER

1. Easements may be required on this site, encroachments will not be permitted.

2. Extension of public sanitary sewer lines may be required to serve this site and those adjacent. Extension of sanitary sewer lines shall be completed in such a manner as to coordinate with other adjacent parcels. A strong preference shall be shown for gravity sanitary sewers. Private sanitary laterals may not cross property lines.
3. Formal plan submittal and approval will be required by the MSD prior to the issuance of permits. Formal plan approval is subject to the requirements of detailed review.

O. GEOTECHNICAL REPORT.

Prior to Site Development Plan approval, provide a geotechnical report, prepared by a registered professional engineer licensed to practice in the State of Missouri, as directed by the Department of Planning and Public Works. The report shall verify the suitability of grading and proposed improvements with soil and geologic conditions and address the existence of any potential sinkhole, ponds, dams, septic fields, etc., and recommendations for treatment. A statement of compliance, signed and sealed by the geotechnical engineer preparing the report, shall be included on all Site Development Plans and Improvement Plans.

P. MISCELLANEOUS

1. All utilities will be installed underground.
2. Prior to record plat approval, the developer shall cause, at his expense and prior to the recording of any plat, the reestablishment, restoration or appropriate witnessing of all Corners of the United States Public Land Survey located within, or which define or lie upon, the outboundaries of the subject tract in accordance with the Missouri Minimum Standards relating to the preservation and maintenance of the United States Public Land Survey Corners.
3. Prior to final release of subdivision construction deposits, the developer shall provide certification by a registered land surveyor that all monumentation depicted on the record plat has been installed and United States Public Land Survey Corners have not been disturbed during construction activities or that they have been reestablished and the appropriate documents filed with the Missouri Department of Natural Resources Land Survey Program.

II. TIME PERIOD FOR SUBMITTAL OF SITE DEVELOPMENT CONCEPT PLANS AND SITE DEVELOPMENT PLANS

- A. The developer shall submit a concept plan within eighteen (18) months of City Council approval of the change of zoning.
- B. In lieu of submitting a Site Development Concept Plan and Site Development Section Plans, the petitioner may submit a Site Development Plan for the entire development within eighteen (18) months of the date of approval of the change of zoning by the City.
- C. Failure to comply with these submittal requirements will result in the expiration of the change of zoning and will require a new public hearing.
- D. Said Plan shall be submitted in accordance with the combined requirements for Site Development Section and Concept Plans. The submission of Amended Site Development Plans by sections of this project to the Planning Commission shall be permitted if this option is utilized.
- E. Where due cause is shown by the developer, this time interval for plan submittal may be extended through appeal to and approval by the Planning Commission.

III. COMMENCEMENT OF CONSTRUCTION

- A. Substantial construction shall commence within two (2) years of approval of the site development concept plan or site development plan, unless otherwise authorized by ordinance.
- B. Where due cause is shown by the developer, the Commission may extend the period to commence construction for not more than one additional year.

IV. GENERAL CRITERIA

A. Site Development Concept Plan.

- 1. Any site development concept plan shall show all information required on a preliminary plat as required in the City of Chesterfield Code.
- 2. The delineation both graphically and a legal description, of all proposed parcel(s) of land and the Residential Zoning District development standards for which the parcels are to be developed. These parcels are to be labeled and accompanied with a table that

clearly depicts the parcel name and the development standards for which it is to be developed.

3. Include a conceptual landscape plan in accordance with the City of Chesterfield Code to indicate proposed landscaping along arterial and collector roadways.
4. Include a lighting plan in accordance with the City of Chesterfield Code to indicate proposed lighting along arterial collector roadways.
5. Provide comments/approvals from the appropriate Fire District, the Metropolitan St. Louis Sewer District, the St. Louis County Department of Highways and Traffic, Monarch Chesterfield Levee District, Spirit of St. Louis Airport and the Missouri Department of Transportation.

B. SITE DEVELOPMENT SECTION PLAN SUBMITTAL REQUIREMENTS

The Site Development Section Plan shall adhere to the above criteria and to the following:

1. Location map, north arrow, and plan scale. The scale shall be no greater than one (1) inch equals one hundred (100) feet.
2. The delineation both graphically as an exhibit and a legal description of all proposed parcel(s) of land. The document will include the location of the Residential Zoning District Development Standards for which the parcel(s) are to be developed. These parcels are to be labeled with a letter or number and accompanied with a table that clearly depicts the parcel name and the development standards for which it is to be developed.
3. Parking calculations. Including calculation for all off street parking spaces, required and proposed, and the number, size and location for handicap designed.
4. Provide open space percentage for overall development including separate percentage for each lot on the plan.
5. Provide Floor Area Ratio (F.A.R.).
6. A note indicating all utilities will be installed underground.
7. A note indicating signage approval is separate process.

8. Depict the location of all buildings, size, including height and distance from adjacent property lines and proposed use.
9. Specific structure and parking setbacks along all roadways and property lines.
10. Indicate location of all existing and proposed freestanding monument signs
11. Zoning district lines, subdivision name, lot number, dimensions, and area, and zoning of adjacent parcels where different than site.
12. Floodplain boundaries.
13. Depict existing and proposed improvements within 150 feet of the site as directed. Improvements include, but are not limited to, roadways, driveways and walkways adjacent to and across the street from the site, and significant natural features, such as wooded areas and rock formations, that are to remain or be removed.
14. Depict all existing and proposed easements and rights-of-way within 150 feet of the site and all existing or proposed off-site easements and rights-of-way required for proposed improvements.
15. Indicate the location of the proposed storm sewers, detention basins, sanitary sewers and connection(s) to the existing systems.
16. Depict existing and proposed contours at intervals of not more than one (1) foot, and extending 150 feet beyond the limits of the site as directed.
17. Address trees and landscaping in accordance with the City of Chesterfield Code.
18. Comply with all preliminary plat requirements of the City of Chesterfield Subdivision Regulations per the City of Chesterfield Code.
19. Signed and sealed in conformance with the State of Missouri Department of Economic Development, Division of Professional Registration, Missouri Board for Architects, Professional Engineers and Land Surveyors requirements.

20. Provide comments/approvals from the appropriate Fire District, the Metropolitan St. Louis Sewer District, Monarch Levee District, Spirit of St. Louis Airport and the Missouri Department of Transportation.
21. Compliance with Sky Exposure Plane.

V. TRUST FUND CONTRIBUTION

The developer shall contribute a Traffic Generation Assessment (TGA) to the Eatherton – Kehrs Mill Road Trust Fund (Trust Fund No. 552). This contribution shall not exceed an amount established by multiplying the ordinance-required parking space by the following rate schedule:

<u>Type of Development</u>	<u>Required Contribution</u>
Single Family	\$992.40/Parking Space

(Parking Space as required by the site specific ordinance or by Section 1003.165 of the St. Louis County Zoning Ordinance)

If types of development/proposed differ from those listed, rates shall be provided by the Saint Louis County Department of Highways and Traffic.

Allowable credits for required roadway improvements will be awarded as directed by the Saint Louis County Department of Highways and Traffic and the City of Chesterfield. Sidewalk construction and utility relocation, among other items, are not considered allowable credits.

As this development is located within a trust fund area established by Saint Louis County any portion of the traffic generation assessment contribution which remains following completion of road improvements required by the development shall be retained in the appropriate trust fund.

The amount of the required contribution, if not approved for construction by January 1, 2012, shall be adjusted on that date and on the first day of January in each succeeding year thereafter in accord with the construction cost index as determined by the Saint Louis County Department of Highways and Traffic.

VI. RECORDING

Within 60 days of approval of any development plan by the City of Chesterfield, the approved Plan will be recorded with the St. Louis County Recorder of Deeds. Failure to do so will result in the expiration of approval of said plan and require re-approval of a plan by the Planning Commission.

VII. ENFORCEMENT

- A. The City of Chesterfield, Missouri will enforce the conditions of this ordinance in accordance with the Plan approved by the City of Chesterfield and the terms of this Attachment A.
- B. Failure to comply with any or all the conditions of this ordinance will be adequate cause for revocation of approvals/permits by reviewing Departments and Commissions.
- C. Non-compliance with the specific requirements and conditions set forth in this Ordinance and its attached conditions or other Ordinances of the City of Chesterfield shall constitute an ordinance violation, subject, but not limited to, the penalty provisions as set forth in the City of Chesterfield Code.
- D. Waiver of Notice of Violation per the City of Chesterfield Code.
- E. This document shall be read as a whole and any inconsistency to be integrated to carry out the overall intent of this Attachment A.

ARBORS AT WILDHORSE CREEK

A TRACT OF LAND BEING A PART OF LOT 7 AND PART OF LOT 8 IN MARY SCHAEFFER ESTATE AND BEING SITUATED IN U.S. SURVEY 150, TOWNSHIP 45 NORTH, RANGE 3 EAST, CITY OF CHESTERFIELD, ST. LOUIS COUNTY, MISSOURI

PRELIMINARY DEVELOPMENT PLAN

GENERAL NOTES:

- THIS SITE IS IN THE FOLLOWING DISTRICTS:
METROPOLITAN ST. LOUIS SEWER DISTRICT
MONARCH FIRE PROTECTION DISTRICT
ROCKWOOD R-6 SCHOOL DISTRICT
- THIS SITE IS IN THE FOLLOWING UTILITY SERVICE AREAS:
MISSOURI AMERICAN WATER COMPANY
AMEREN UE
AT&T
LACLEDE GAS COMPANY
CHARTER COMMUNICATIONS
- SANITARY SEWER CONSTRUCTION AND CONNECTIONS SHALL BE AS APPROVED BY THE METROPOLITAN ST. LOUIS SEWER DISTRICT AND IN ACCORDANCE WITH THE STANDARD CONSTRUCTION SPECIFICATIONS FOR SEWERS AND DRAINAGE FACILITIES.
- STORM WATER SYSTEM SHALL BE DESIGNED PURSUANT TO THE CITY OF CHESTERFIELD AND METROPOLITAN ST. LOUIS SEWER DISTRICT REQUIREMENTS AND DISCHARGE AT AN ADEQUATE NATURAL DISCHARGE POINT.
- NO SLOPES SHALL EXCEED 3 (HORIZONTAL) TO 1 (VERTICAL), UNLESS JUSTIFIED BY GEOTECHNICAL REPORT WHICH HAS BEEN ACCEPTED/APPROVED BY THE CITY OF CHESTERFIELD.
- THE LOCATION OF STORM AND SANITARY SEWER IMPROVEMENTS ARE APPROXIMATE ONLY. ACTUAL LOCATION SHALL BE DETERMINED BY FIELD CONDITIONS AND SHALL BE INDICATED ON THE IMPROVEMENT PLANS.
- GRADING SHALL BE PER CITY OF CHESTERFIELD STANDARDS. SOURCE OF TOPOGRAPHY MSD ORTHOTOPO.
- STREET TREES AND STREET LIGHTS (UNLESS OTHERWISE DEPICTED) SHALL BE PER CITY OF CHESTERFIELD STANDARDS.
- PROJECT IDENTIFICATION SIGNS SHALL HAVE A MAXIMUM AREA OF FIFTY (50) SQUARE FEET, A MAXIMUM HEIGHT OF SIX (6) FEET, AND SHALL REMAIN OUTSIDE OF THE THIRTY (30) FOOT SIGHT DISTANCE TRIANGLE.
- NEAREST MAJOR INTERSECTION IS WILDHORSE CREEK ROAD AND LONG ROAD.
- ALL SIDEWALKS SHALL BE CONSTRUCTED TO ADA AND THE CITY OF CHESTERFIELD STANDARDS.
- EXISTING OWNERS: 17560 WILDHORSE CREEK, LLC
1422 PAULAND PLACE
CHESTERFIELD, MO 63005-4319
- SITE TO CONFORM TO THE CITY OF CHESTERFIELD TREE REQUIREMENTS.
- MAXIMUM HEIGHT OF THE RESIDENCES WILL NOT EXCEED 50 FEET.

SITE INFORMATION

LOCATOR NUMBERS: 18V330046
 EXISTING ZONING: NU
 PROPOSED ZONING: E1 PLANNED UNIT DEVELOPMENT (E1-PUD)
 GROSS AREA OF SITE: 23.42 ACRES
 DENSITY CALCULATIONS: $\frac{23.42 \text{ AC} \times 43,560 \text{ SQ.FT./AC.}}{43,560 \text{ SQ.FT./LOT}} = 23 \text{ LOTS ALLOWED}$
 AVERAGE LOT SIZE: 26,630 S.F.
 MAXIMUM NUMBER OF UNITS ALLOWED: 23
 NUMBER OF UNITS PROPOSED: 22
 LOT DEVELOPMENT REQUIREMENTS:
 FRONT YARD SETBACK 20'
 SIDE YARD SETBACK 10'
 REAR YARD SETBACK 25'
 MIN. LOTS SIZE 24,000 SQ. FT.
 NUMBER OF PARKING SPACES: TWO PER UNIT = 44 SPACES.
 PROPOSED STREETS SHALL BE PUBLIC 26' WIDE PAVEMENT WITH 50' WIDE R.O.W.
 COMMON GROUND = 7.50 ACRES WHICH EQUALS 32.0% OF THE SITE.
 FLOOD MAP: FIRM NO. 29189C0120H DATED 08-02-95

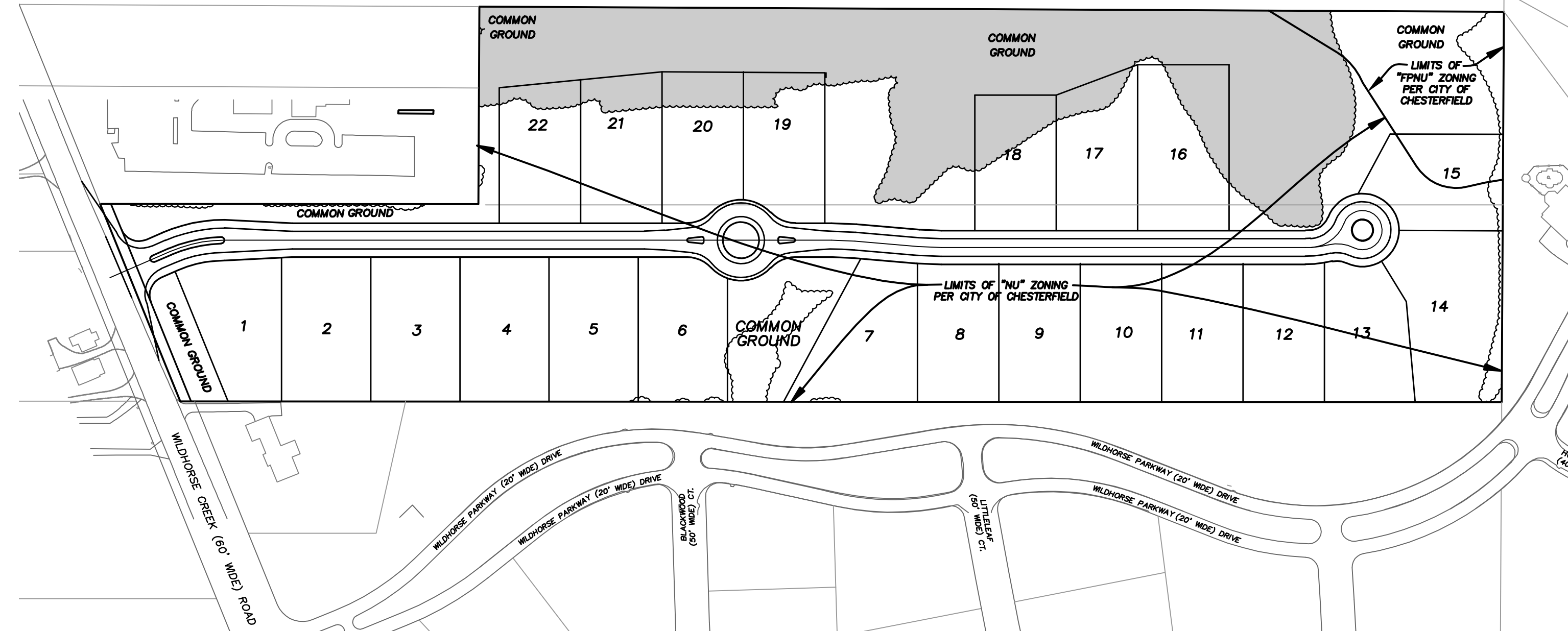

PROJECT ZIP CODE: 63005

LEGAL DESCRIPTION

A TRACT OF LAND BEING ALL OF LOT 1 OF "MARY SCHAEFFER ESTATE ADJUSTMENT"; A SUBDIVISION ACCORDING TO THE PLAT THEREOF RECORDED IN PLAT BOOK 352, PAGE 809 OF THE ST. LOUIS COUNTY, MISSOURI RECORDS, SITUATED IN U.S. SURVEY 150, TOWNSHIP 45 NORTH, RANGE 3 EAST OF THE FIFTH PRINCIPAL MERIDIAN, CITY OF CHESTERFIELD, ST. LOUIS COUNTY, MISSOURI AND BEING MORE PARTICULARLY DESCRIBED AS FOLLOWS:

BEGINNING AT THE NORTHWEST CORNER OF ABOVE SAID LOT 1, SAID CORNER BEING THE INTERSECTION OF THE SOUTH RIGHT-OF-WAY LINE OF WILDHORSE CREEK ROAD (60 FEET WIDE) AND THE WEST LINE OF LOT 7 OF "MARY SCHAEFFER ESTATE"; A SUBDIVISION ACCORDING TO THE PLAT THEREOF RECORDED IN PLAT BOOK 17, PAGE 4 OF ABOVE SAID RECORDS; THENCE ALONG SAID SOUTH RIGHT-OF-WAY LINE OF WILDHORSE CREEK ROAD, NORTH 55 DEGREES 15 MINUTES 36 SECONDS EAST, 314.28 FEET TO A POINT BEING THE NORTHWEST CORNER OF LOT 2 OF ABOVE SAID "MARY SCHAEFFER ESTATE ADJUSTMENT"; THENCE LEAVING SOUTH RIGHT-OF-WAY LINE AND ALONG THE WEST LINE OF SAID LOT 2, SOUTH 12 DEGREES 36 MINUTES 16 SECONDS EAST, 558.02 FEET TO POINT BEING THE SOUTHWEST CORNER OF SAID LOT 2; THENCE LEAVING LAST SAID WEST LINE AND ALONG THE SOUTH LINE OF SAID LOT 2, NORTH 77 DEGREES 39 MINUTES 28 SECONDS EAST, 291.46 FEET TO A POINT BEING THE SOUTHEAST CORNER OF SAID LOT 2, SAID POINT ALSO BEING ON THE EAST LINE OF LOT 8 OF SAID "MARY SCHAEFFER ESTATE"; THENCE LEAVING LAST SAID SOUTH LINE AND ALONG THE EAST LINE OF SAID LOT 8, SOUTH 12 DEGREES 22 MINUTES 00 SECONDS EAST, 1511.00 FEET TO THE SOUTHEAST CORNER OF SAID LOT 8; THENCE LEAVING LAST SAID EAST LINE AND ALONG THE SOUTH LINE OF SAID LOT 8 AND ITS PROLONGATION, BEING THE SOUTH LINE OF SAID LOT 7, SOUTH 77 DEGREES 39 MINUTES 28 SECONDS WEST, 576.03 FEET TO A POINT BEING THE SOUTHWEST CORNER OF SAID LOT 7; THENCE LEAVING LAST SAID SOUTH LINE AND ALONG THE WEST LINE OF SAID LOT 7, NORTH 12 DEGREES 36 MINUTES 48 SECONDS WEST, 1949.28 FEET TO THE POINT OF BEGINNING AND CONTAINS 1,020,280 SQUARE FEET, OR 23.42 ACRES, MORE OR LESS.

SURVEYORS CERTIFICATION

THIS IS TO CERTIFY THAT WE HAVE, DURING THE MONTH OF JUNE, 2011, AT THE REQUEST OF MCBRIDE WILDHORSE, LLC PREPARED A PRELIMINARY DEVELOPMENT PLAN OF "ARBORS AT WILDHORSE CREEK", A TRACT OF LAND BEING A PART OF LOT 7 AND PART OF LOT 8 IN MARY SCHAEFFER ESTATE BEING SITUATED IN U.S. SURVEY 150, TOWNSHIP 45 NORTH, RANGE 3 EAST, CITY OF CHESTERFIELD, ST. LOUIS COUNTY, MISSOURI. THIS PLAN IS NOT A SURVEY AND DOES NOT MEET THE "MISSOURI MINIMUM STANDARDS FOR PROPERTY BOUNDARY SURVEYS" (10 CSR 30-2 AND 4 CSR 30-16 EFFECTIVE DATE DECEMBER 30, 1994).

THE STERLING COMPANY

George J. Gower - Vice President
 MO. Reg. L.S. - #2336

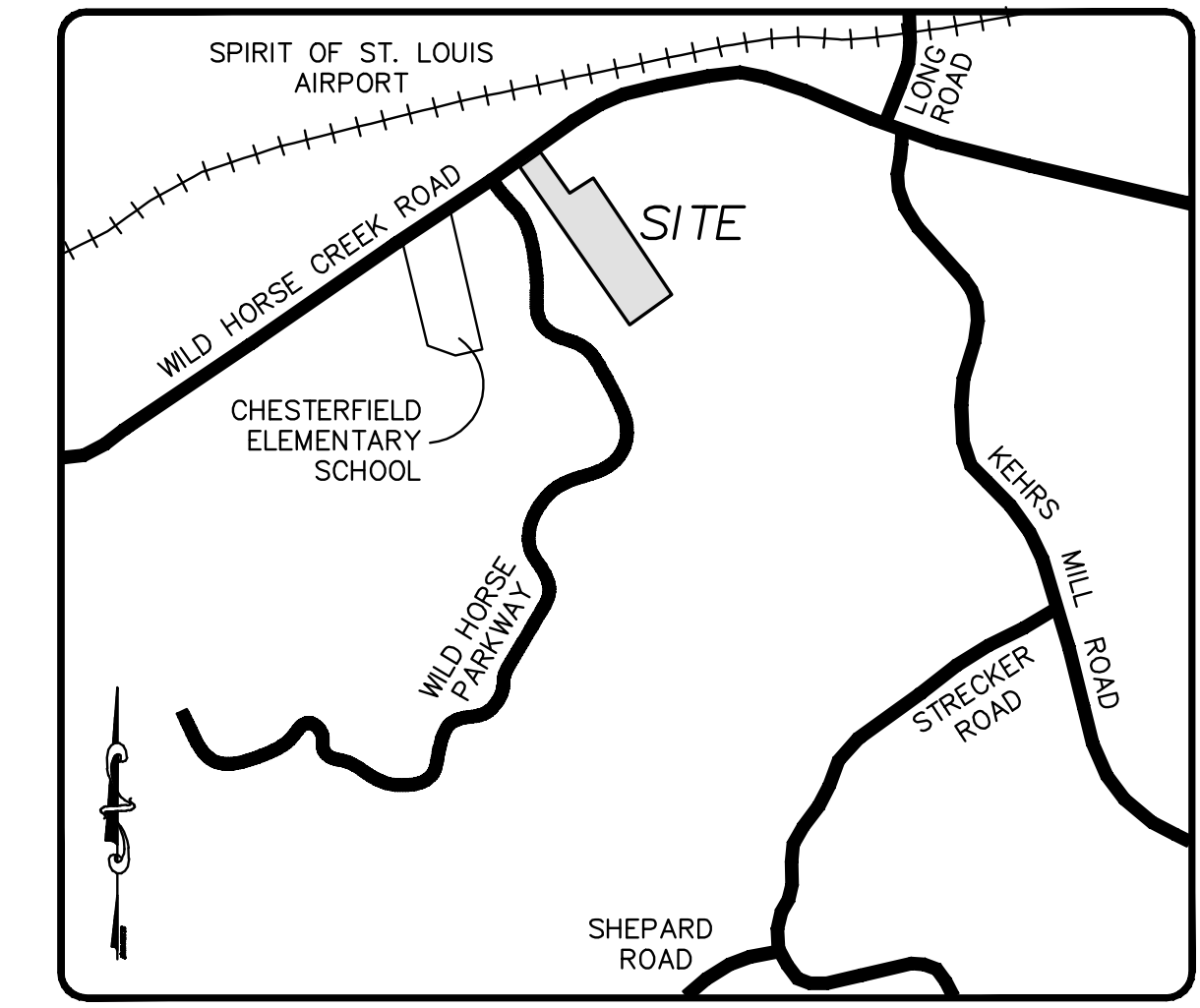

LOCATION MAP
 N.T.S.

LEGEND

EXISTING	PROPOSED
642	647
1856	556.0
CONTOURS	CONTOURS
SPOT ELEVATIONS	SPOT ELEVATIONS
CH-NTR LINE	CH-NTR LINE
BUILDINGS, ETC.	BUILDINGS, ETC.
TRE LINE	TRE LINE
FENCE	FENCE
STORM SEWERS	STORM SEWERS
SANITARY SEWERS	SANITARY SEWERS
CATCH BASIN	CATCH BASIN
AREA INLET	AREA INLET
GRATE INLET	GRATE INLET
STORM MANHOLE	STORM MANHOLE
SANITARY MANHOLE	SANITARY MANHOLE
HARD-Pipe SECTION	HARD-Pipe SECTION
CIVIL OUT	CIVIL OUT
UTILITY CONNECTION	UTILITY CONNECTION
UTILITY OR POWER POLE	UTILITY OR POWER POLE
HYD-RANT	HYD-RANT
TR-STOP	TR-STOP
PAV-MENT	PAV-MENT
GAS MAIN & S/L	GAS MAIN & S/L
WATER MAIN & S/L	WATER MAIN & S/L
TR-STOP	TR-STOP
ELECTRIC (U) UNDERGROUND	ELECTRIC (U) UNDERGROUND
OWW	OWW
ELECTRIC (O) OVERHEAD	ELECTRIC (O) OVERHEAD
HOW LINE	HOW LINE
TO BE REMOVED	TO BE REMOVED
TOP OF CURB	TOP OF CURB
SWAL	SWAL
LIGHT STANDARD	LIGHT STANDARD
STREET SIGN	STREET SIGN
P.S.	P.S.
PARKING STALLS	PARKING STALLS
YARD LIGHT	YARD LIGHT

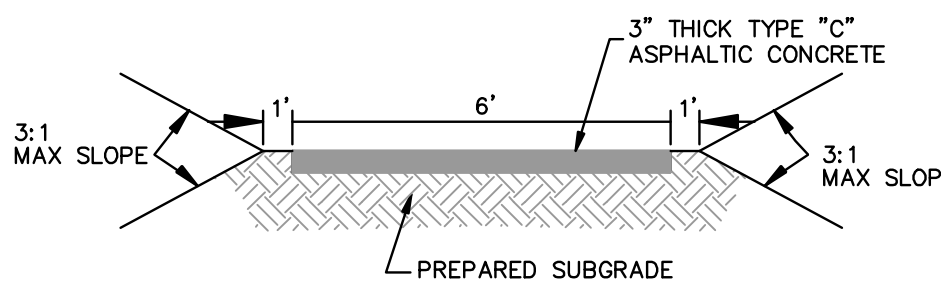

ASPHALT WALKING PATH
 (NOT TO SCALE)

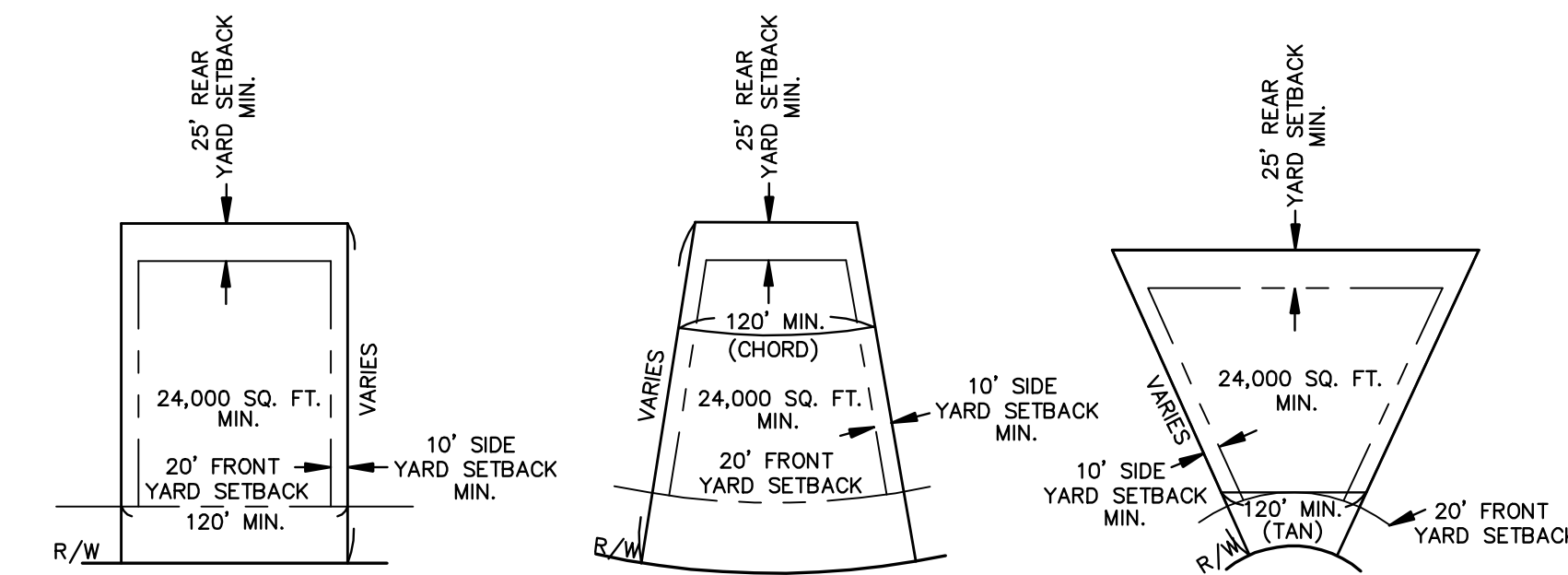

TYPICAL LOT
 NOT TO SCALE

McBride Wildhorse, LLC
 5081 New Baumgartner Road
 St. Louis, Missouri 63129
 Ph. 314-487-6717

THE STERLING CO.
 ENGINEERS & SURVEYORS
 5055 New Baumgartner Road
 St. Louis, Missouri 63129
 Ph. 314-487-0440 Fax. 314-487-9944
 www.sterling-eng-survey.com
 Corporate Certificate of Authority #001948

Arbors at Wildhorse Creek
 Chesterfield, Missouri
 COVER SHEET

Date: 6-3-2011
 MICHAEL G. BOERDING
 License No. E-28643
 Civil Engineer

Job Number: 11-01-002
 Date: JUNE 3, 2011
 Designed: Sheet
 Drawn: 1.1
 Checked: PRE

MSD Base Map 18V
 MSD P #
 Highway & Traffic #

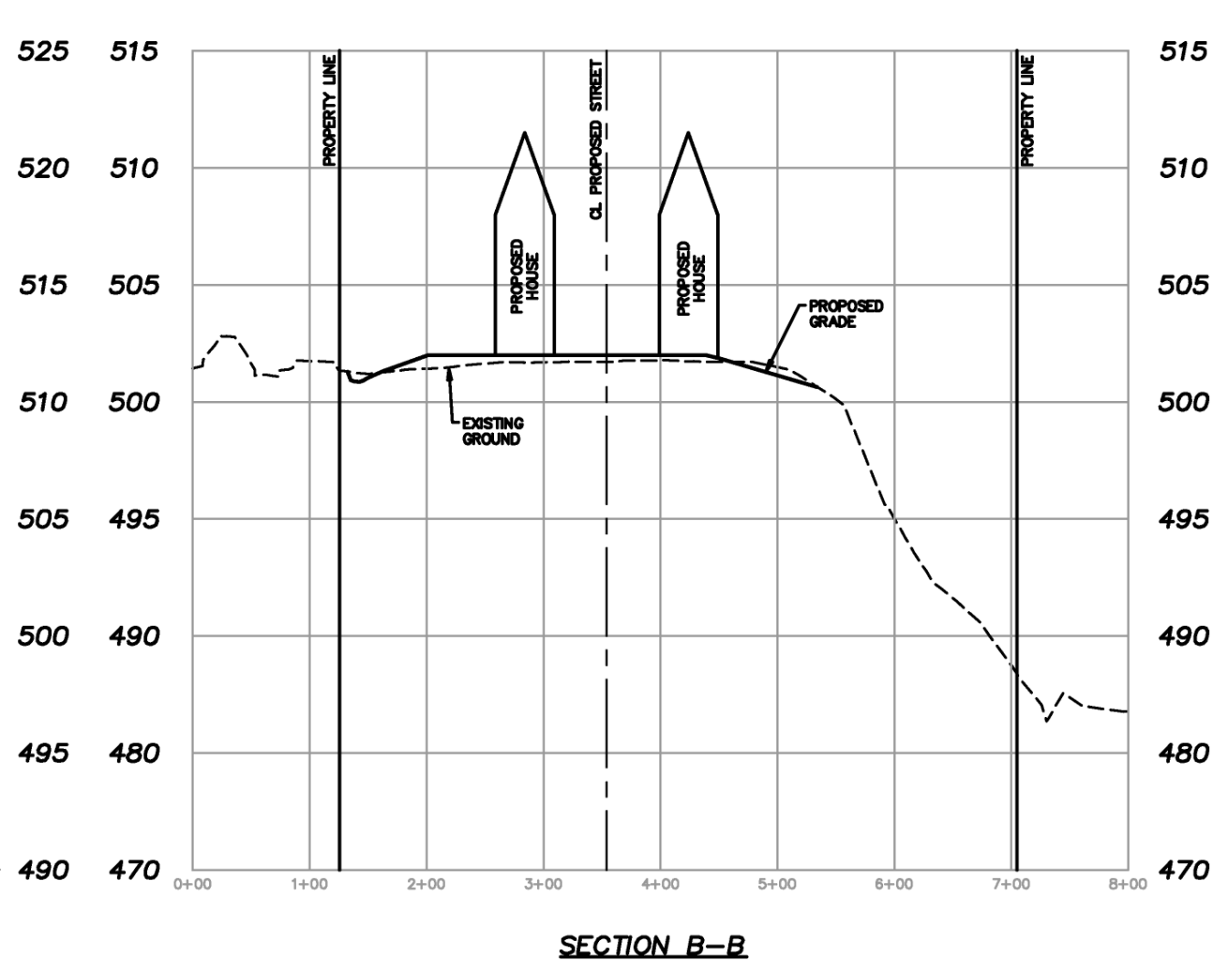
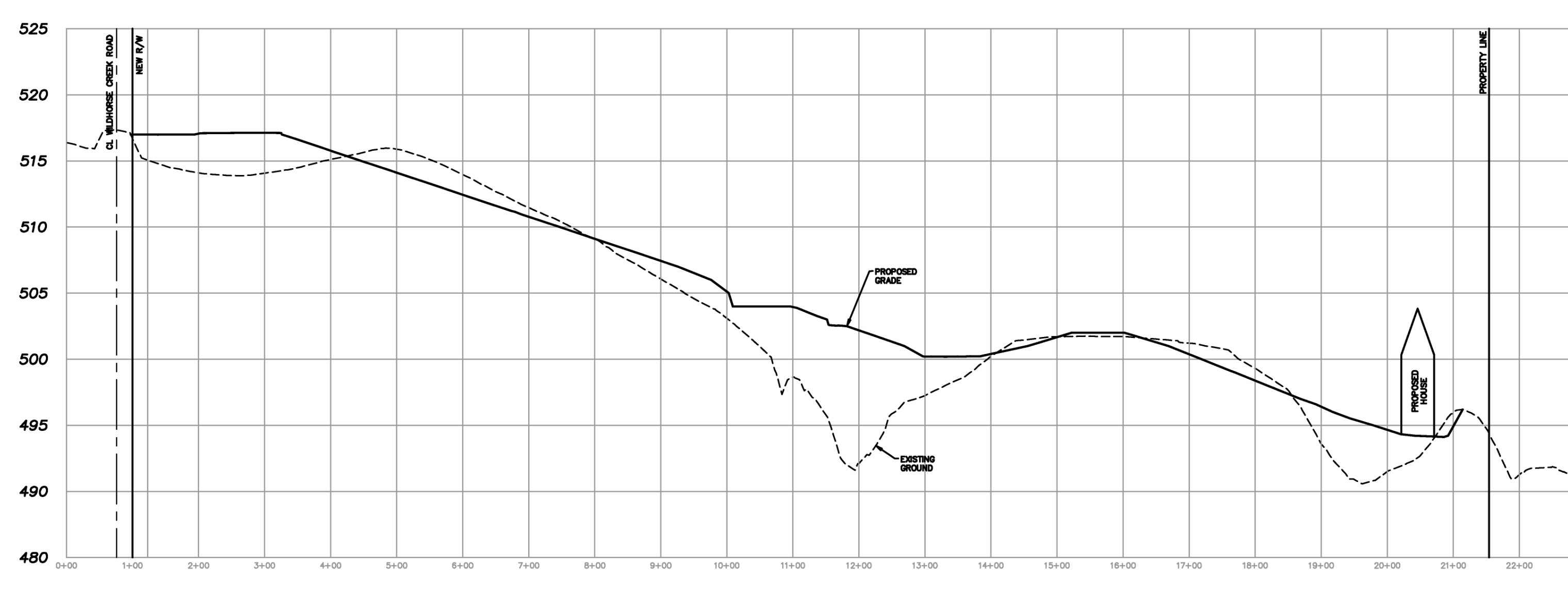
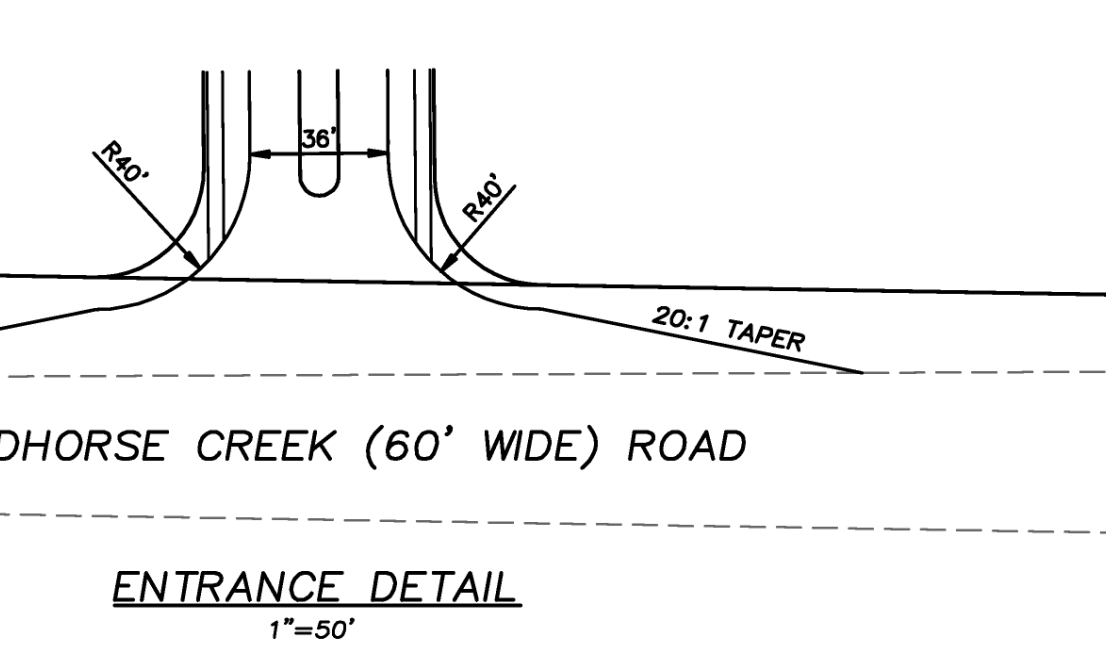
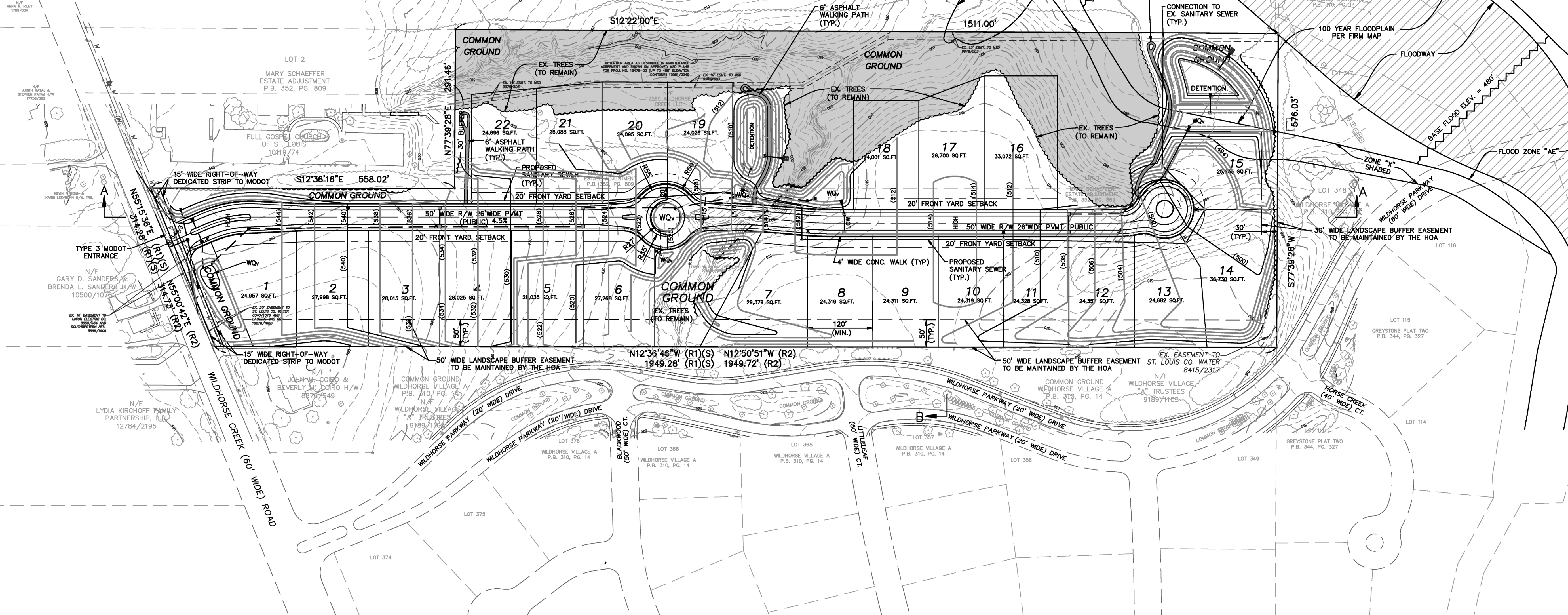
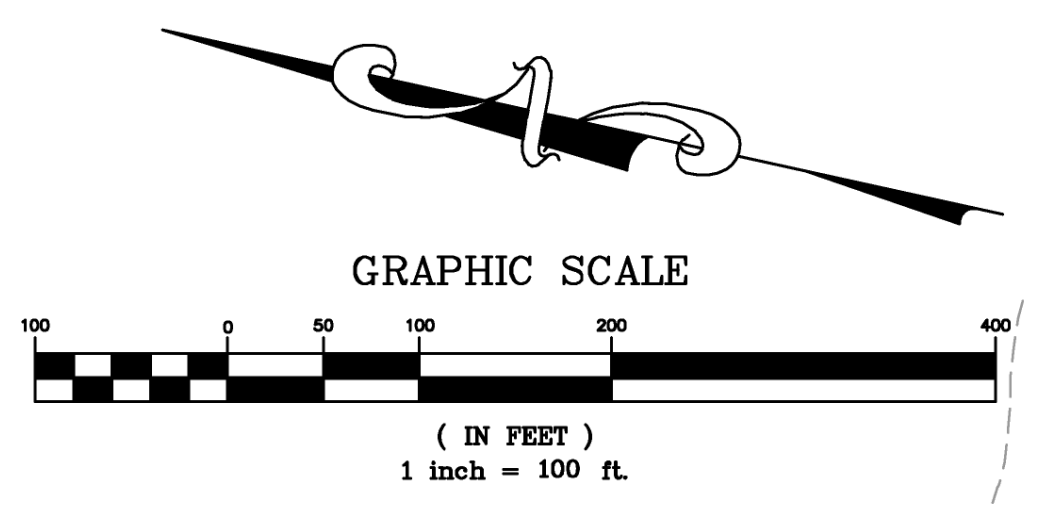

Drawing name: K11161002 Wildhorse Creek 23 Arborg/Planetary/1000dms.dwg Plotted on: Jul 06, 2011 - 8:17am Plotted by: mchael

THE UNDERGROUND UTILITIES SHOWN HEREON WERE PLOTTED FROM AVAILABLE INFORMATION AND DO NOT NECESSARILY REFLECT THE ACTUAL EXISTENCE, NONEXISTENCE, SIZE, TYPE, NUMBER OR LOCATION OF THESE OR OTHER UTILITIES. THE GENERAL CONTRACTOR SHALL BE RESPONSIBLE FOR VERIFYING THE ACTUAL LOCATION OF ALL UNDERGROUND UTILITIES, SHOWN OR NOT SHOWN, AND SAID UTILITIES SHALL BE LOCATED IN THE FIELD PRIOR TO ANY GRADING, EXCAVATION OR CONSTRUCTION OF IMPROVEMENTS. THESE PROVISIONS SHALL IN NO WAY ABSOLVE ANY PARTY FROM COMPLYING WITH THE UNDERGROUND FACILITY SAFETY AND DAMAGE PREVENTION ACT, CHAPTER 319, RSMo

ISSUE	REMARKS/DATE
1	8-3-2011, INITIAL SUBMITTAL

McBride Wildhorse, LLC
 5091 New Baumgartner Road
 St. Louis, Missouri 63129
 Ph. 314-487-6717

THE STERLING CO.
ENGINEERS & SURVEYORS
 5055 New Baumgartner Road
 St. Louis, Missouri 63129
 Ph. 314-487-0440 Fax 314-487-9944
 www.sterling-eng-srv.com
 Corporate Certificate of Authority #001948

Arbors at Wildhorse Creek
 Chesterfield, Missouri
PRELIMINARY PLAN

The Professional Engineer and/or Surveyor shall be responsible for verifying the actual location of all underground utilities, shown or not shown, and said utilities shall be located in the field prior to any grading, excavation or construction of improvements. These provisions shall in no way absolve any party from complying with the Underground Facility Safety and Damage Prevention Act, Chapter 319, RSMo.

Date: 8-3-2011
 MICHAEL G. BOERDING
 License No. E-28843
 Civil Engineer

Job Number: 11-01-002
 Date: JUNE 3, 2011
 Designed: Sheet
 Drawn: 2.1
 Checked: PRE

MSD Base Map 18V
 MSD P#
 Highway & Traffic #

THE UNDERGROUND UTILITIES SHOWN HEREON WERE PLOTTED FROM AVAILABLE INFORMATION AND DO NOT NECESSARILY REFLECT THE ACTUAL EXISTENCE, NONEXISTENCE, SIZE, TYPE, NUMBER OR LOCATION OF THESE OR OTHER UTILITIES. THE GENERAL CONTRACTOR SHALL BE RESPONSIBLE FOR VERIFYING THE ACTUAL LOCATION OF ALL UNDERGROUND UTILITIES, SHOWN OR NOT SHOWN, AND SAID UTILITIES SHALL BE LOCATED IN THE FIELD PRIOR TO ANY GRADING, EXCAVATION OR CONSTRUCTION OF IMPROVEMENTS. THESE PROVISIONS SHALL IN NO WAY ABSOLVE ANY PARTY FROM COMPLYING WITH THE UNDERGROUND FACILITY SAFETY AND DAMAGE PREVENTION ACT, CHAPTER 319, RSMo

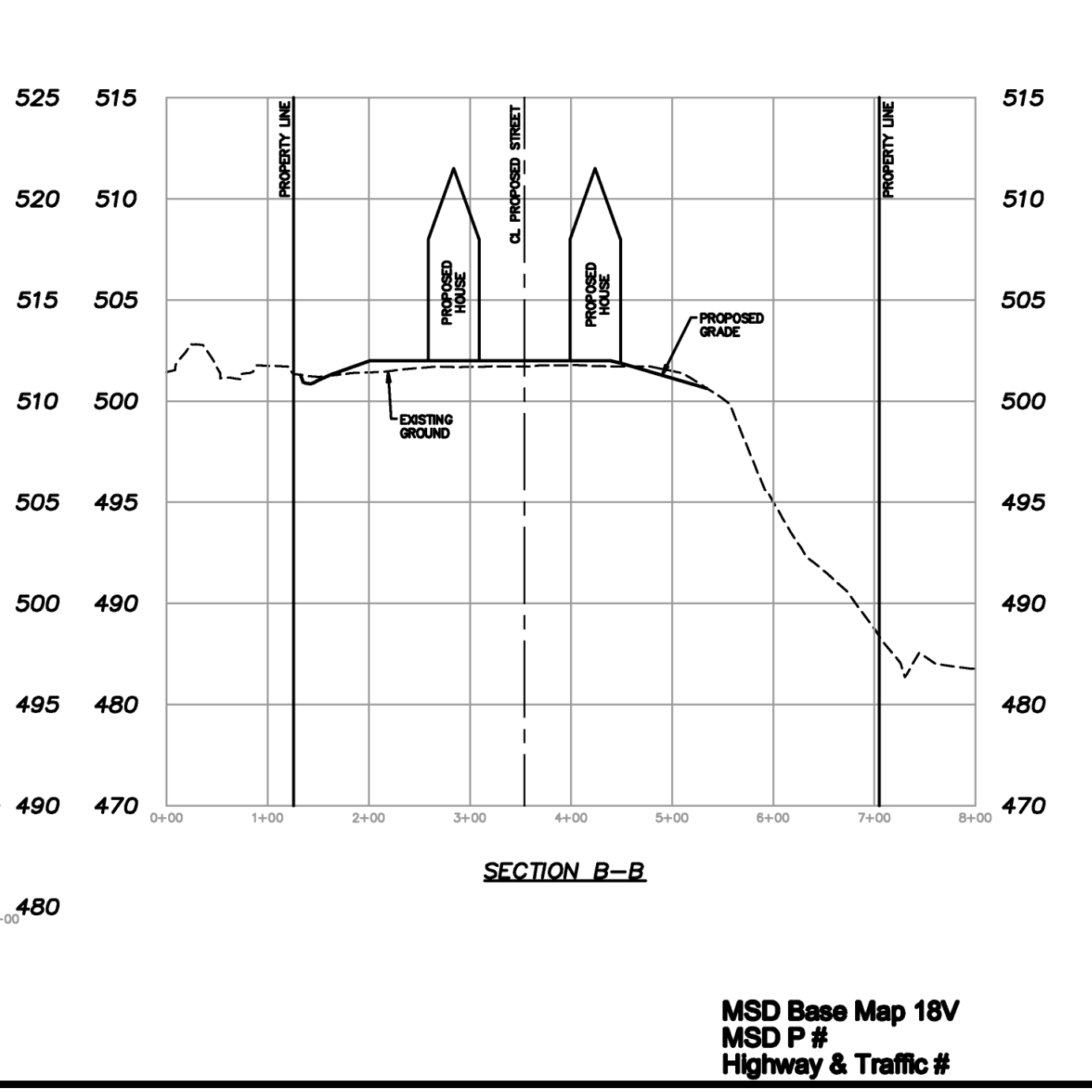
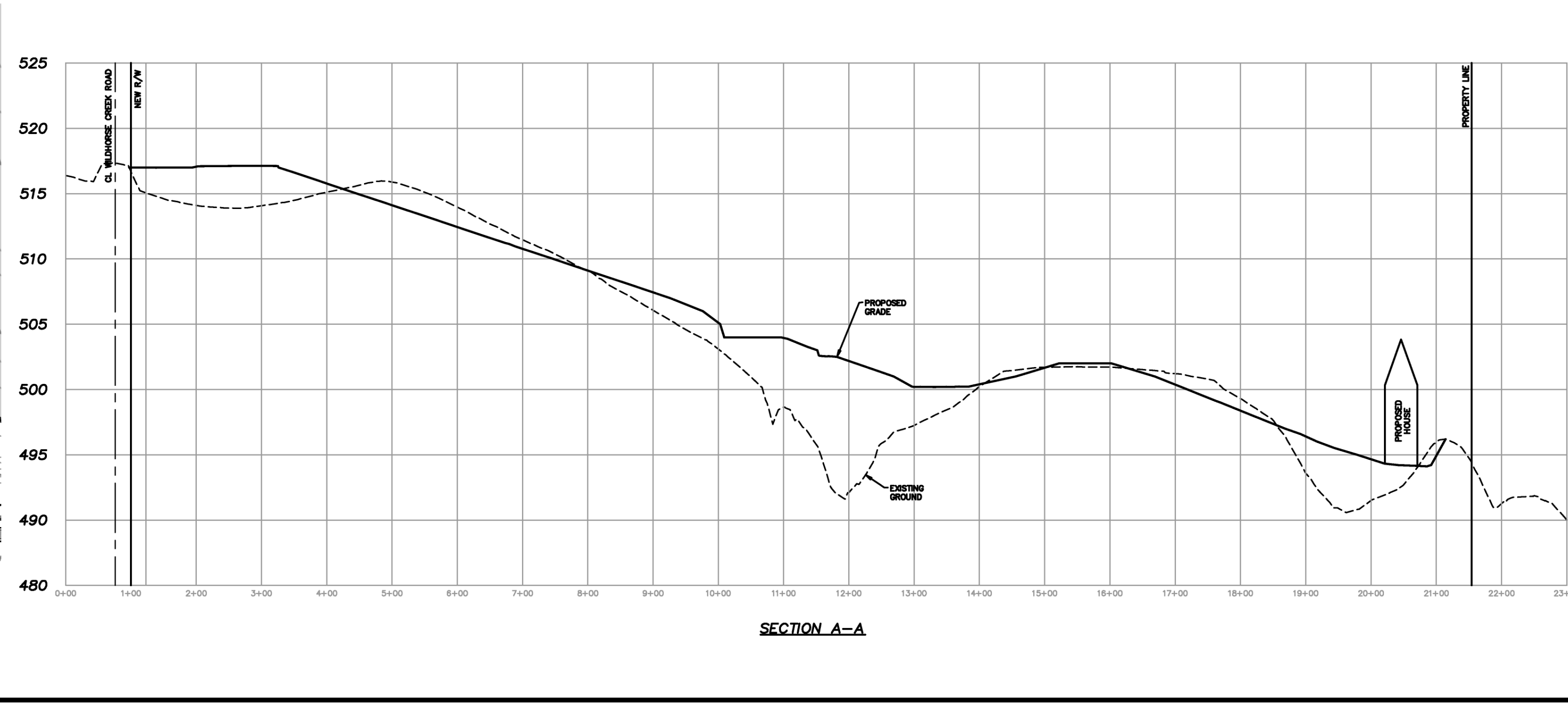
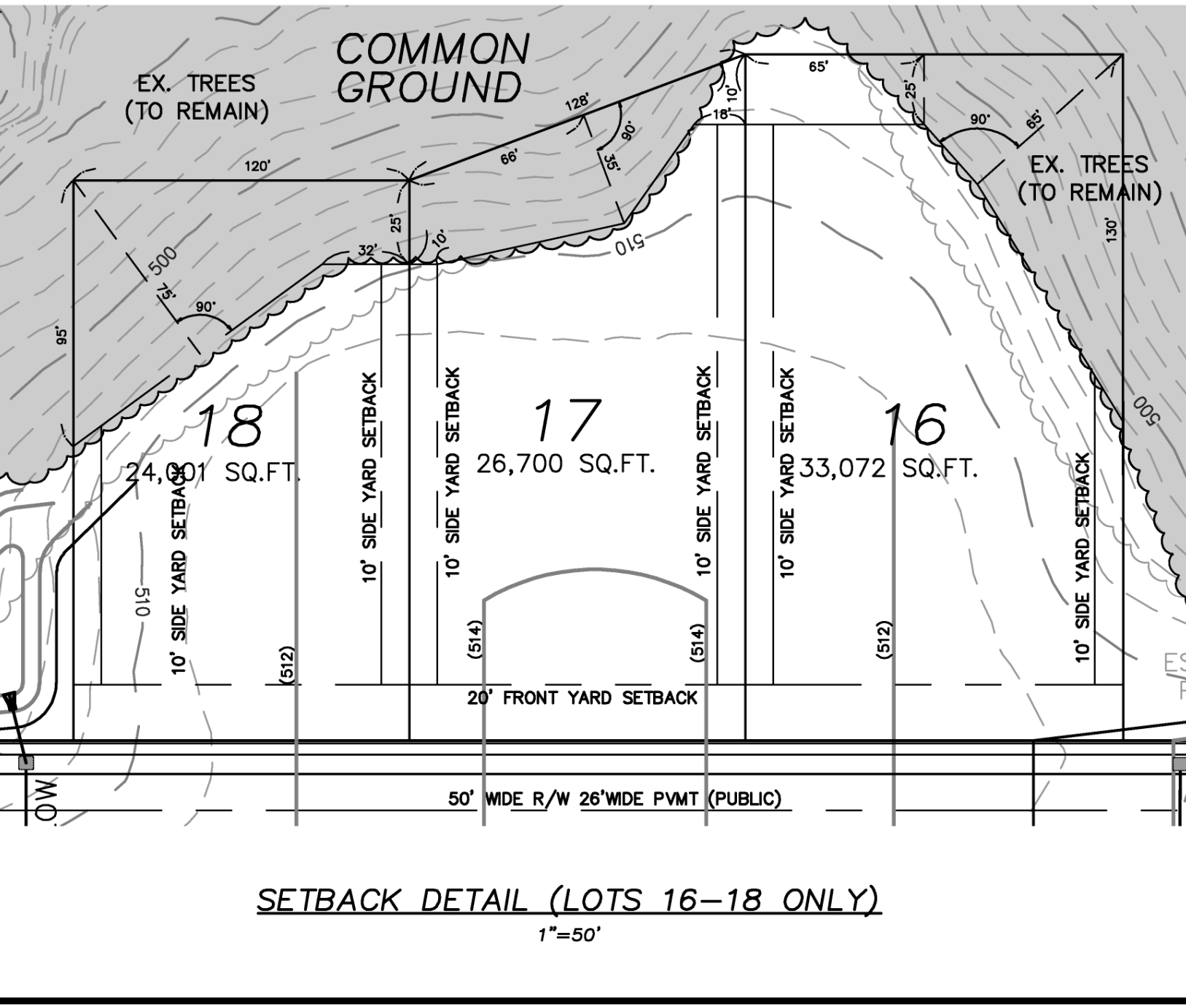
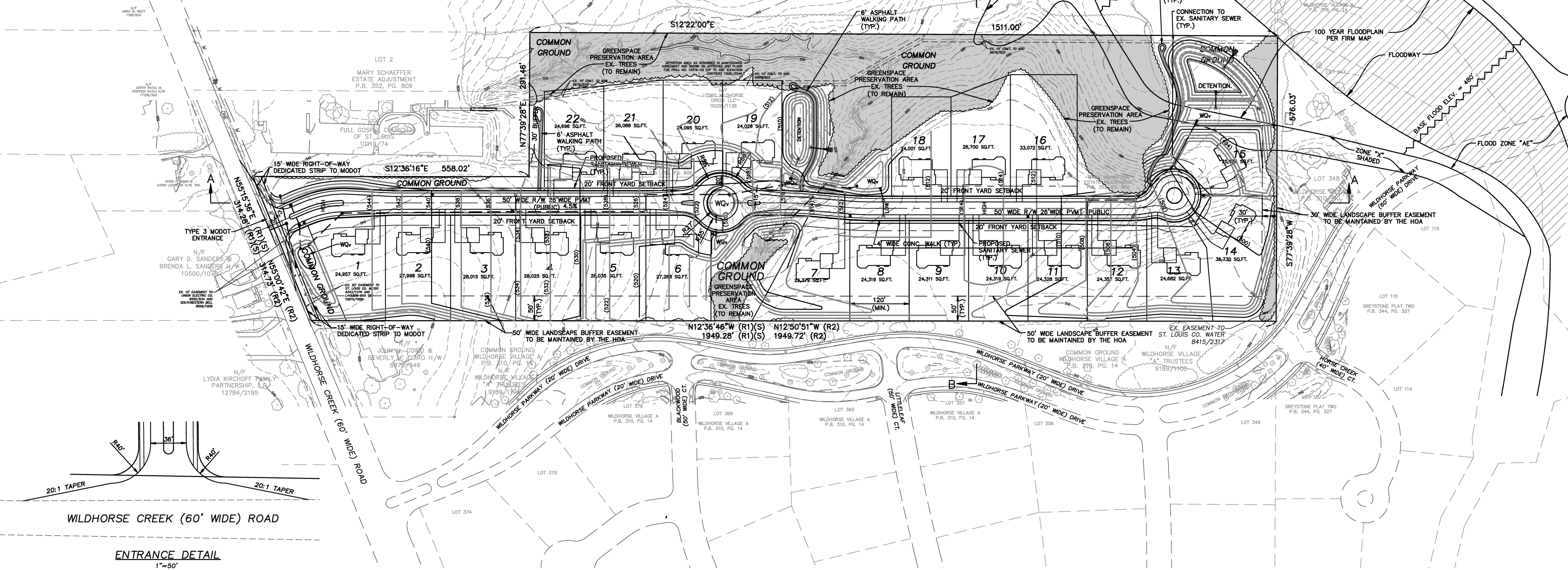
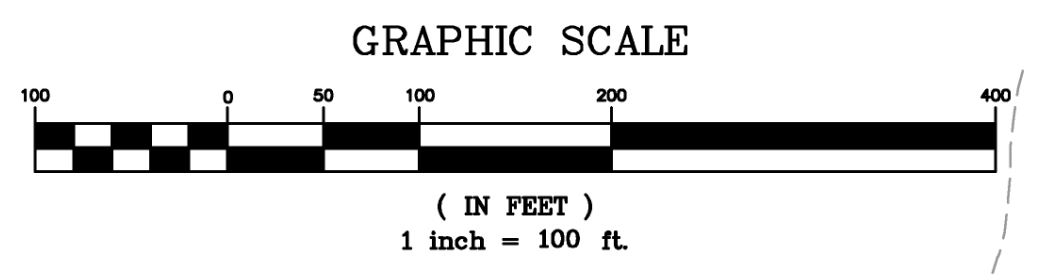

ISSUE	REMARKS/DATE
1	8-29-2011, INITIAL SUBMITTAL
2	9-15-2011, CITY COMMENTS

McBride Wildhorse, LLC
 5091 New Baumgartner Road
 St. Louis, Missouri 63129
 Ph. 314-487-6717

THE STERLING CO.
 ENGINEERS & SURVEYORS
 5055 New Baumgartner Road
 St. Louis, Missouri 63129
 Ph. 314-487-0440 Fax 314-487-9944
 www.sterling-eng-srv.com
 Corporate Certificate of Authority #001948

Arbors at Wildhorse Creek
 Chesterfield, Missouri
 PRELIMINARY PLAN

Date: **MICHAEL G. BOERDING**
 License No. E-28843
 Civil Engineer

Job Number: **11-01-002**
 Date: **AUG. 29, 2011**
 Designed: _____ Sheet
 Drawn: **2.1**
 Checked: **PRE**

MSD Base Map 18V
 Highway & Traffic #

Drawing name: K11101002 Wildhorse Creek 23 Arborg/Preliminary/1000.dwg Plotted on: Sep 15, 2011 - 11:04am Plotted by: abowman