

Memorandum

Department of Planning & Development Services



To: Planning and Public Works Committee

From: Andrew Stanislav, Planner *AS*

Date: May 9, 2019

RE: **POWER OF REVIEW Monarch Center, Partial Amended Sign Package:**
A request for a Partial Amended Sign Package for Lot A (Edison Express) of Monarch Center.

Summary

Edison Real Estate, LLC has submitted a request for a partial amendment to the existing Sign Package for Lot A of the Monarch Center Development, which contains the Edison Express convenience store, gas station, car wash, and restaurant. The purpose of the amendment is to request additional signage in conjunction with the installation of a new tenant in the restaurant portion of the building. The request is limited to the Edison Express development and no changes are requested to the signage requirements for the lots within the Monarch Center development.

This project was reviewed by the Planning Commission at the April 22, 2019 meeting at which time a motion to deny the request was passed by a vote of 7-0. Subsequently, Power of Review was exercised in accordance with Section 31-02-20 of the Unified Development Code. The Planning Commission packet is attached.

Attachments: April 22, 2019 Planning Commission Packet



Figure 1: Monarch Center, Lot A (Edison Express)



690 Chesterfield Pkwy W • Chesterfield MO 63017-0760
Phone: 636-537-4000 • Fax 636-537-4798 • www.chesterfield.mo.us

Planning Commission Staff Report

Project Type: Partial Amended Sign Package
Meeting Date: April 22, 2019
From: Jessica Henry, Assistant City Planner
Location: Northeast quadrant of Long Road and Edison Avenue
Applicant: Edison Real Estate, LLC.
Description: **Monarch Center, Partial Amended Sign Package**: A request for a Partial Amended Sign Package for Lot A (Edison Express) of Monarch Center.

PROPOSAL SUMMARY

Edison Real Estate, LLC has submitted a request for a partial amendment to the existing Sign Package for Lot A of the Monarch Center Development, which contains the Edison Express convenience store, gas station, car wash, and restaurant. The purpose of the amendment is to request additional signage in conjunction with the installation of a new tenant in the restaurant portion of the building. The request is limited to the Edison Express development and no changes are requested to the signage requirements for the lots within the Monarch Center development. A previous Sign Package request was approved in three separate parts by the Planning Commission in late 2016/early 2017. **The current request is for additional signage and revisions to the signage associated with the restaurant tenant as detailed in the matrix provided by the applicant. All other existing and/or future signage shall conform to the existing approved Sign Package.**



Figure 1: Monarch Center, Lot A (Edison Express)

The purpose of a Sign Package is to provide comprehensive and complementary signage throughout a development. The UDC states that “in order to encourage superior design, quality and character, comprehensive Sign Packages allow for specialized review of signs and flexibility from standard signage requirements.”



Figure 2: Edison Express wall signage on west elevation (March 2017)

HISTORY

On February 5, 2007, the City of Chesterfield approved Ordinance 2334 which rezoned the property from “NU” Non-Urban District to “PC” Planned Commercial District. Subsequently, the property owner submitted a request for an ordinance amendment in 2013. Per the property owner’s request, in August 2013, the City of Chesterfield approved Ordinance 2753 to allow for the addition of a 0.85 acre parcel of land (zoned “M-3”) to be rezoned and included under the same planned district ordinance, resulting in a new “PC” Planned Commercial District totaling 10.97 acres. Ordinance 2753 also amended various building and parking setbacks and made modifications, such as a slight increase in the allowable floor area permitted within the development, to account for the addition of land. The requirement that a Sign Package be submitted for this development was specifically included by the Planning Commission during the initial zoning. This requirement remained in place when the site specific ordinance was amended by Ordinance 2753, which currently governs the site.

In September of 2014, the Site Development Section Plan for the Edison Express development was approved by the Planning Commission and City Council. Subsequently, the Site Development Section Plan and Architectural Elevations were amended in 2015 and 2016 to permit for minor revisions. The Boundary Adjustment Plat establishing the three lots was also approved in 2015. A previous Sign Package request was approved in three separate parts by the Planning Commission in late 2016/early 2017.

In 2018, Ordinance 3006 removed Lot C of the Monarch Center development and incorporated it into St. Louis Family Church’s campus. At the time of development of this lot, the new property owners will be able to file a separate Sign Package application to remove Lot C from the current Monarch Center Sign Package.

LAND USE AND ZONING OF SURROUNDING PROPERTIES

Land Use and Zoning of Surrounding Properties:

The land use and zoning for the properties surrounding this parcel are as follows:

North: The property to the north of the subject site is currently zoned “PI” Planned Industrial District (Pohlman Industrial Park).

South: The property to the south of the subject site is currently zoned “PC” Planned Commercial District and is currently vacant (Edison Crossing).

East: The property to the east of the subject site is currently zoned “PI” Planned Industrial District (St. Louis Family Church).

West: The property to the west of the subject site is currently zoned “PC” Planned Commercial District (Monarch Fire Protection District and Tower Centre).

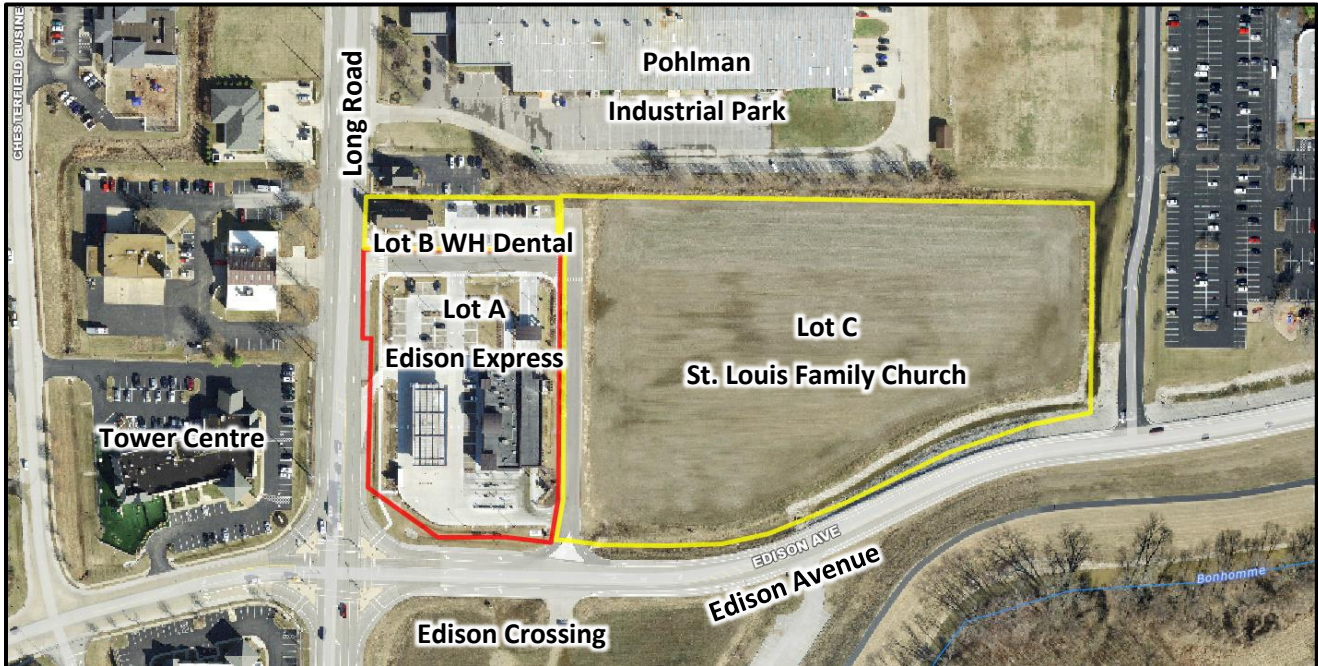

Figure 3: Surrounding Developments

COMPREHENSIVE PLAN ANALYSIS

The Comprehensive Plan serves as the City’s guiding document in implementing the Community’s vision for development. There is one specific Plan Policy pertaining to signage that has been adopted as part of the Comprehensive Plan, as follows:

- **Plan Policy 3.4.1 Preserve Aesthetics and Public Safety** – To preserve the high aesthetic quality and public safety interests along the corridor and other major highways/roads, signs of ever-increasing size, brightness and garishness should be prohibited.

SUBMITTAL OVERVIEW

This Sign Package request is specific to attached wall signage on the west, north, and south elevations of the Edison Express convenience store, gas station, carwash, and restaurant building. A panel change on the monument sign is also shown; however, this change is already permitted under the existing sign package. All other signage throughout the Monarch Center will conform to the requirements established in the existing Sign Package. The signage requests for each elevation will be presented separately in the following sections of this report.

1. **West Elevation, Attached Wall Signage** – The west elevation is the primary building elevation and is parallel to Long Road. The following images compare the approved attached wall signage to the current request, and the areas where a change in signage is requested are identified in red. A table after each set of images provides information about the size and number of signs proposed. Note that while the current request calculates each element of each existing and proposed sign separately, the original Sign Package grouped the elements of each sign together for calculations purposes. For the purposes of making an accurate comparison, the west elevation total signage table below shows both the original size calculations as presented in the previously approved Sign Package for the existing signs that are proposed to remain as well as the calculation method used in the current request where signage elements are separated.

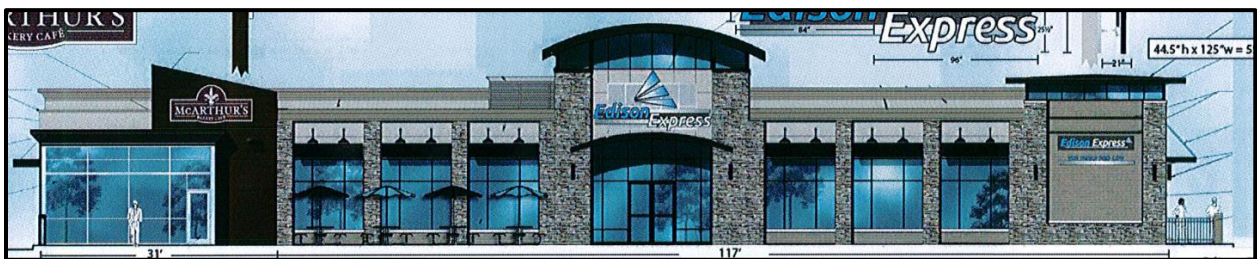

Figure 4: West Elevation—Approved wall signage



Figure 5: West Elevation—Requested wall signage

Sign #	Currently Approved	Requested
1	1 sign, 55 sqft	1 sign, 72.1 sqft
2	No sign in this location	1 sign, 9.2 sqft
3	No sign in this location	1 flipframe sign, 87.55 sqft

West Elevation Total Signage		
	Square Feet	% of Elevation
Currently Approved	211.1	6.8
Requested (Existing signage elements grouped together)	315.75	10.2
Requested (Existing signage elements separated)	241.91	7.8

2. **North Elevation, Attached Wall Signage** – The north elevation contains the drive-thru for the restaurant tenant space. The branded awnings that are currently installed are proposed to be replaced with solid black awnings. The following images compare the approved attached wall signage to the current request, and the areas where a change in signage is requested are identified in red. A table after each set of images provides information about the size and number of signs proposed.

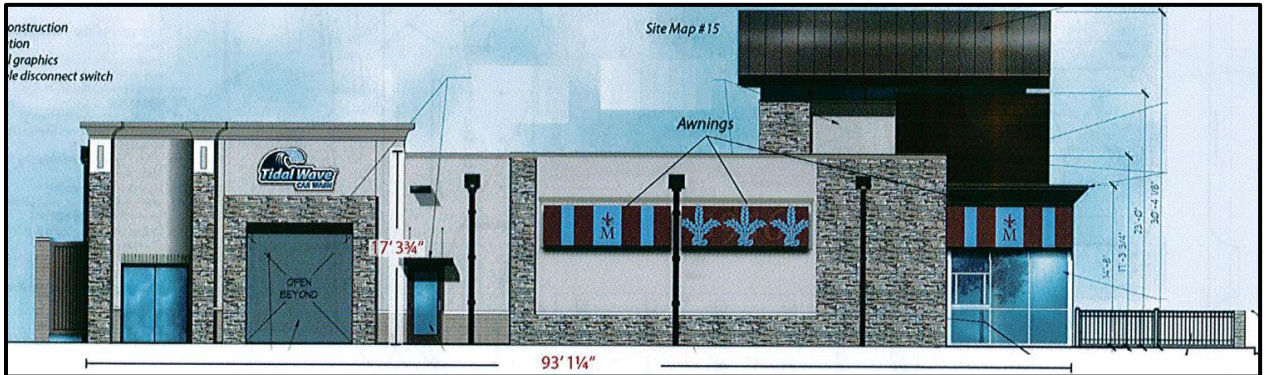

Figure 6: North Elevation—Approved wall signage

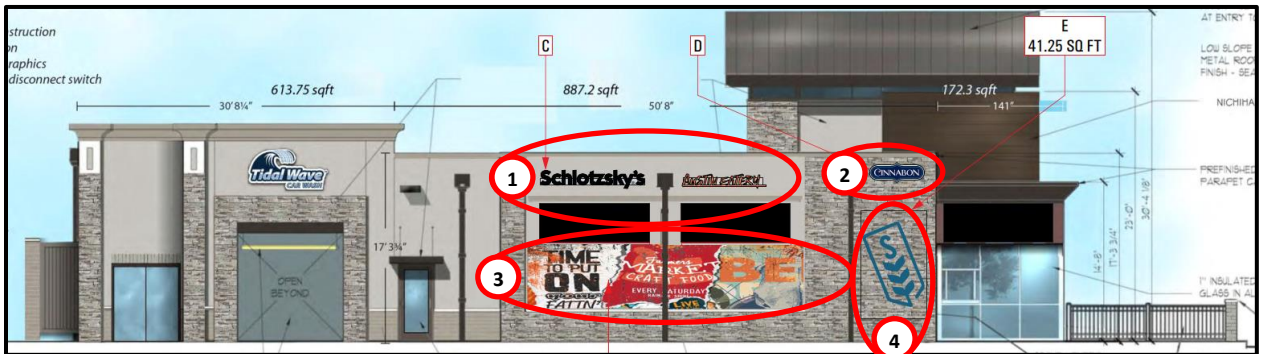

Figure 7: North Elevation—Requested wall signage

Sign #	Currently Approved	Requested
1	No sign in this location	2 signs, totaling 34.2sqft
2	No sign in this location	1 sign, 9.2 sqft
3	No sign in this location	1 graffiti mural, 137 sqft
4	No sign in this location	1 sign, 41.25 sqft

North Elevation Total Signage		
	Square Feet	% of Elevation
Currently Approved	31.3	1.8
Requested	252.95	15.1

- South Elevation, Attached Wall Signage** – The south elevation is situated parallel to Edison Road. The following images compare the approved attached wall signage to the current request, and the areas where a change in signage is requested are identified in red. A table after each set of images provides information about the size and number of signs proposed.



Figure 8: South Elevation—Approved wall signage



Figure 9: South Elevation—Requested wall signage

Sign #	Currently Approved	Requested
1	No sign in this location	1 sign, totaling 27.9 sqft
2	No sign in this location	1 sign, 9.2 sqft

West Elevation Total Signage		
	Square Feet	% of Elevation
Currently Approved	31.3	1.8
Requested	68.4	4.13

STAFF ANALYSIS

This partial amended Sign Package request for the Edison Express development substantially increases the amount of signage on each of the three impacted elevations. The request does not propose eliminating any signage elsewhere within the development to compensate for or mitigate the requested increase. While there are multiple uses within this building, the proposed signage for the restaurant tenant is spread across three elevations rather than being contained to the exterior walls of the particular tenant space.

The purpose of a sign package, which serves as the mechanism for allowing modifications to the UDC sign regulations, is to provide comprehensive, complementary, and unified signage throughout a development. The UDC states that “in order to encourage superior design, quality and character, comprehensive sign packages allow for specialized review of signs and flexibility from standard signage requirements.”

The UDC includes the following review factors that are to be considered by the Planning Commission when discussing the appropriateness of the requested flexibility in sign criteria:

1. The physical impact of the proposed comprehensive sign package;
2. The quality of the proposed comprehensive sign package; and
3. Mitigation of unfavorable conditions such as excessive signs, light spillover from signs, height, and other related conditions and potentially negative impacts.

RECOMMENDATION

Staff has reviewed the proposed partial amended Sign Package for Monarch Center, Lot A (Edison Express) and all required items have been included. Staff recommends that the Planning Commission take action on this request.

MOTION

The following options are provided to the Planning Commission for consideration relative to this application:

- 1) “I move to approve (or deny) the partial amended Sign Package for Monarch Center, Lot A (Edison Express).”
- 2) “I move to approve the partial amended Sign Package for Monarch Center, Lot A (Edison Express) with the following conditions.....” (Conditions may be added, eliminated, altered or modified)

Attachments: Partial Amended Sign Package Submittal



Sales: Rhonda Lambert
Project Manager: Andrea Cooksey

158 Long Rd
Chesterfield, MO 63005

Edison Express Amended Sign Package

Table of Contents

- Page 1 - Cover Page
- Page 2 - Front Elevation
- Page 3 - Right Elevation
- Page 4 - Left Elevation
- Page 5 - 24" Wireway Mounted Channel Letters: Stacked
- Page 6 - 16" Wireway Mounted Channel Letters: Stacked
- Page 7 - 16" Wireway Mounted Channel Letters: Linear
- Page 8 - 22"x 60" Cinnabon Wall Cabinet
- Page 9 - Monument Elevation: Tenant Panel RTA Vinyl
- Page 10 - Wheat "S" Mural
- Page 11 - Flip Frame
- Page 12 - Graffiti Mural

Revision Notes

- Rev #1:** CM 2-14-19 Updated Wall Signage; Awnings; Monument
- Rev #2:** JAC 3-29-19 Added Graffiti Mural & Flip Frame. Updated several SQ FT



SIGN COMPANY LLC.
731-925-4448 • 800-953-3744 • Fax 731-926-2022
www.designteam.net

A	24" Wireway Mounted Channel Letters - Stacked
D	22"x 60.2" Cinnabon Wall Cabinet
F	Flipframe Wall Sign

Monarch Center Sign Package

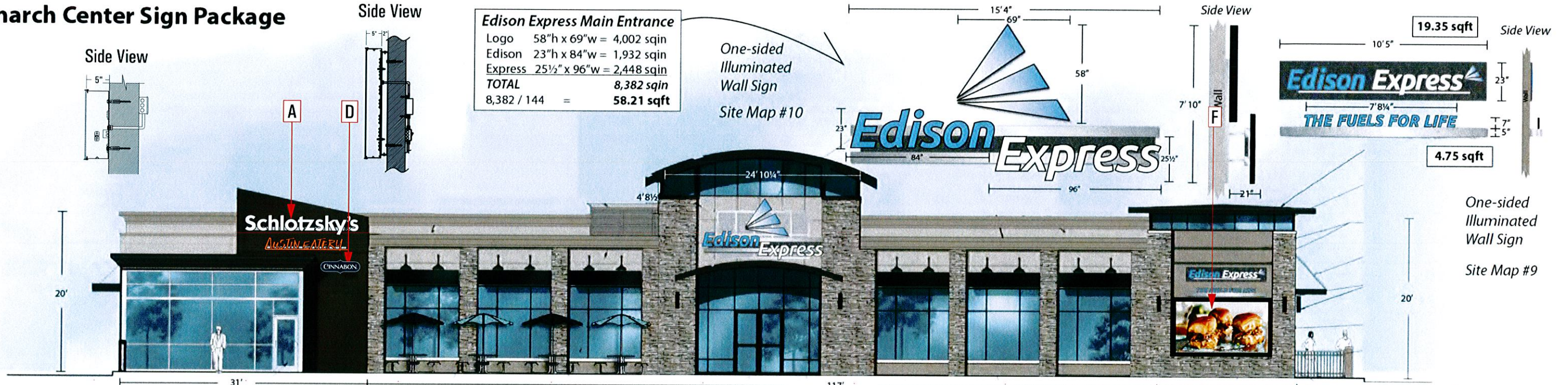

Schlotzsky's Store Frontage
 20' x 31' = 620 Sq Ft
 10% = 62 Sq Ft
 SAE = 62.9 Sq Ft
 Cinnabon = 9.2 Sq Ft
 Total = 72.1 Sq Ft

Total Frontage = 3077 sqft
 5% = 158.85
 Total Area of ALL Signs = 241.91

Edison Express Store Frontage
 20' x 117' = 2340 sqft
 4' 8½" x 24' 10¼" = 117 sqft
 2340 + 117 = 2757sqft
 5% = 137.85
 Signs = 169.81

WEST ELEVATION

- Rev 1: CM 2-14-19 Moved Cinnabon Sign; Added Flipframe
- Rev 2: JAC 3-28-19 Updated Square Footage; Changed to "West Elevation"
- Rev 3:
- Rev 4:
- Rev 5:



Designer: MEB	Date: 2-5-19	Option #1 - MEB
Client: Schlotzsky's - 158 Long Rd		
File Path: z/Restaurant/Schlotzskys/ChesterfieldMO/CP		

- Proof Is Approved. Proceed With Production Of Order
- Proof Is Approved With Corrections. Make Corrections As Indicated And Proceed With Production Of Order

Signature: _____
 I have reviewed this proof in regard to: Sign type; order quantity; and accuracy of icons, symbols, and text (e.g. spelling capitalization, punctuation).
 Print Name: _____
 Date: _____



These plans are the exclusive property of Design Team Sign Company and are the result of the original work of its employees. They are submitted to your company for the sole purpose of your consideration of whether to purchase these plans or to purchase from Design Team Sign Company a product manufactured according to these plans. Distribution or exhibition of the plans to anyone other than employees of your company, or use of these plans to construct a product similar to one embodied herein, is expressly forbidden. In the event that exhibition or construction occurs, Design Team Sign

- B 16" Wireway Mounted Channel Letters - Perfed & Stacked
- D 22"x 60.2" Cinnabon Wall Cabinet

Schlotsky's®

AUSTIN EATERY

Monarch Center Sign Package



- Aluminum channel construction
- LED internal illumination
- Acrylic face with vinyl graphics
- UL Listed with lockable disconnect switch

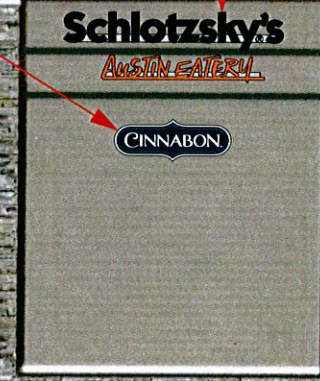
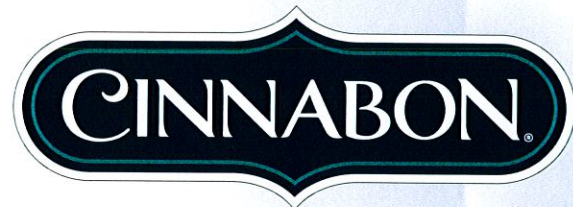

INSULATED TINTED GLASS IN ALUMINUM FRAME
STONE VENEER
STONE FENCE PIER WITH CAST STONE CAP
METAL FENCE - BLACK

PRE-FINISHED METAL SCUPPER AND DOWNSPOUT

METAL FENCE - BLACK
STONE FENCE PIER WITH CAST STONE CAP
MED. STYLE ALUMINUM FRAMED DOOR WITH 10" BOTTOM RAIL - 1/4" CLEAR TEMP. GLASS W/LOW E COATING

CARWASH EXIT WITH HEIGHT LIMITATION BAR

UTILITY SIZE FACE BRICK

One-sided
Illuminated
Wall Sign

Frontage = 1656.1 sqft
6% = 99.4 sqft
All Signs = 68.4 Sq Ft

Rev 1: Updated Square Footage - JAC - 3/29/19

Rev 2:

Rev 3:

Rev 4:

Rev 5:

SOUTH EL



Designer: MEB	Date: 2-5-19	Option #1 - MEB
Client: Schlotsky's - 158 Long Rd		
File Path: z/Restaurant/Schlotskys/ChesterfieldMO/CP		

- Proof Is Approved. Proceed With Production Of Order
- Proof Is Approved With Corrections. Make Corrections As Indicated And Proceed With Production Of Order

Signature: _____
Print Name: _____
Date: _____



These plans are the exclusive property of Design Team Sign Company and are the result of the original work of its employees. They are submitted to your company for the sole purpose of your consideration of whether to purchase these plans or to purchase from Design Team Sign Company a product manufactured according to these plans. Distribution or exhibition of the plans to anyone other than employees of your company, or use of these plans to construct a product similar to one embodied herein, is expressly forbidden. In the event that exhibition or construction occurs, Design Team Sign

C	16" Wireway Mounted Channel Letters - Perfed
D	22"x 60.2" Cinnabon Wall Cabinet
E	Wheat S Symbol on 1/8" Alum. Backer 90" x 66"
F	Graffiti Mural 68.5" x 288"

Schlottzsky's®

AUSTIN EATERY

Monarch Center Sign Package

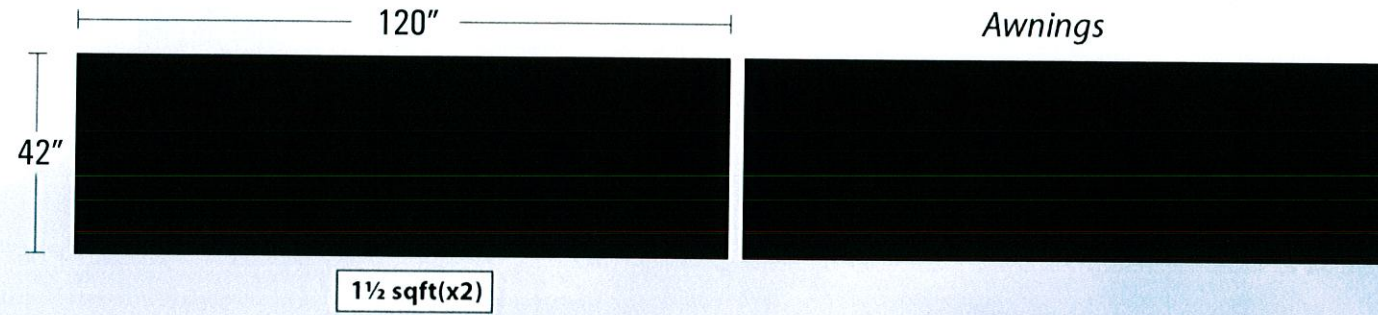

• Black Corrugated Metal to go over Existing Frames

- Aluminum channel construction
- LED internal illumination
- Acrylic face with vinyl graphics
- UL Listed with lockable disconnect switch



Frontage = 1673.25 sqft
 5% = 83.7 sqft
 All Signs = 252.94 Sq Ft

Graffiti Mural Artwork to be Provided by Customer Prior to Fabrication 137 SQ FT

- Rev 1: CM 2-14-19 Added Graffiti Mural, Revised Awning Material
- Rev 2: JAC 3-29-19 Updated Wheat Mural, Added and Updated Square Footage
- Rev 3:
- Rev 4:
- Rev 5:



Designer: MEB	Date: 2-5-19	Option #1 - MEB
Client: Schlottzsky's - 158 Long Rd		
File Path: z/Restaurant/Schlottzskys/ChesterfieldMO/CP		

- Proof Is Approved. Proceed With Production Of Order
- Proof Is Approved With Corrections. Make Corrections As Indicated And Proceed With Production Of Order

Signature: _____
 I have reviewed this proof in regard to: Sign type, order quantity, and accuracy of icons, symbols, and text (e.g. spelling capitalization, punctuation).
 Print Name: _____
 Date: _____



These plans are the exclusive property of Design Team Sign Company and are the result of the original work of its employees. They are submitted to your company for the sole purpose of your consideration of whether to purchase these plans or to purchase from Design Team Sign Company a product manufactured according to these plans. Distribution or exhibition of the plans to anyone other than employees of your company, or use of these plans to construct a product similar to one embodied herein, is expressly forbidden. In the event that exhibition or construction occurs, Design Team Sign Company expects to be reimbursed \$500 in compensation for

For West Elevation

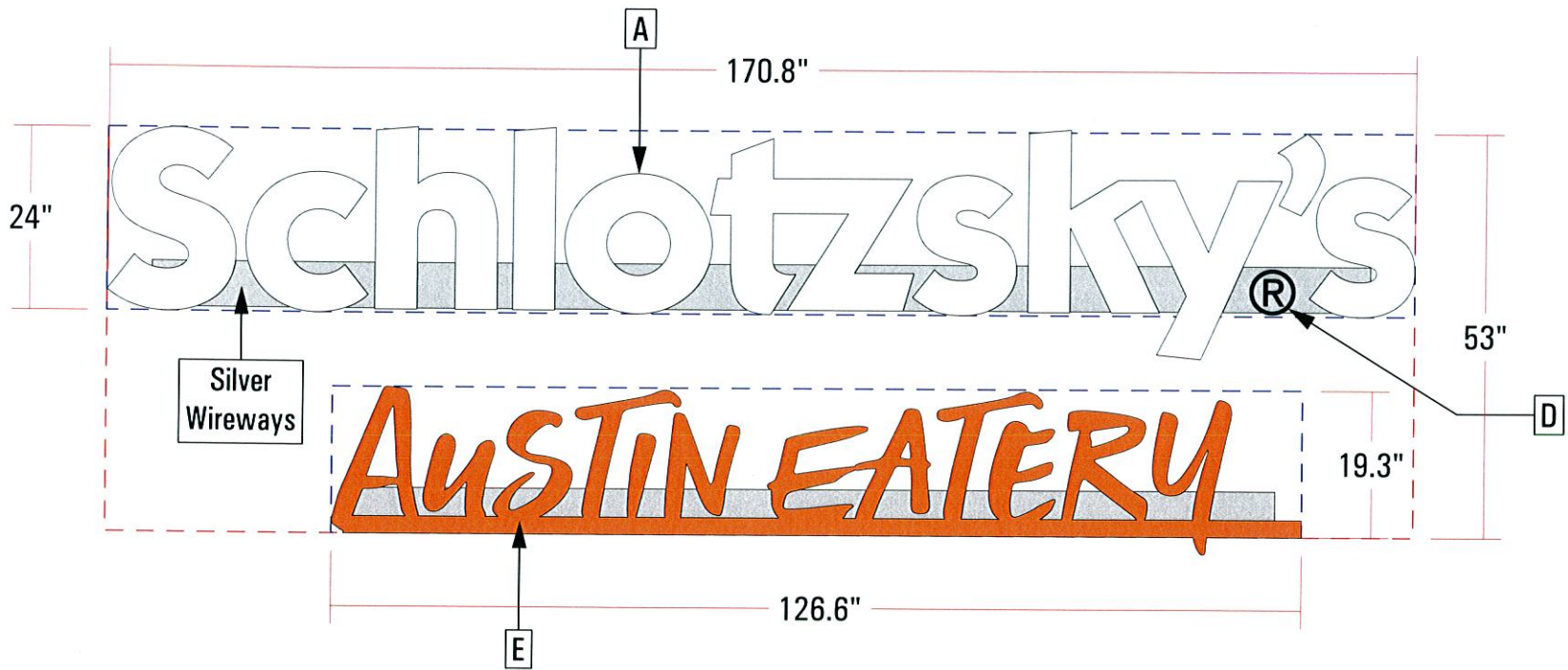

24"x 170.8" = 28.5
 19.3"x 126.6" = 17.0
 Actual Sq Ft = 45.5

Total Sq Ft: 53"x 170.8" = 62.9

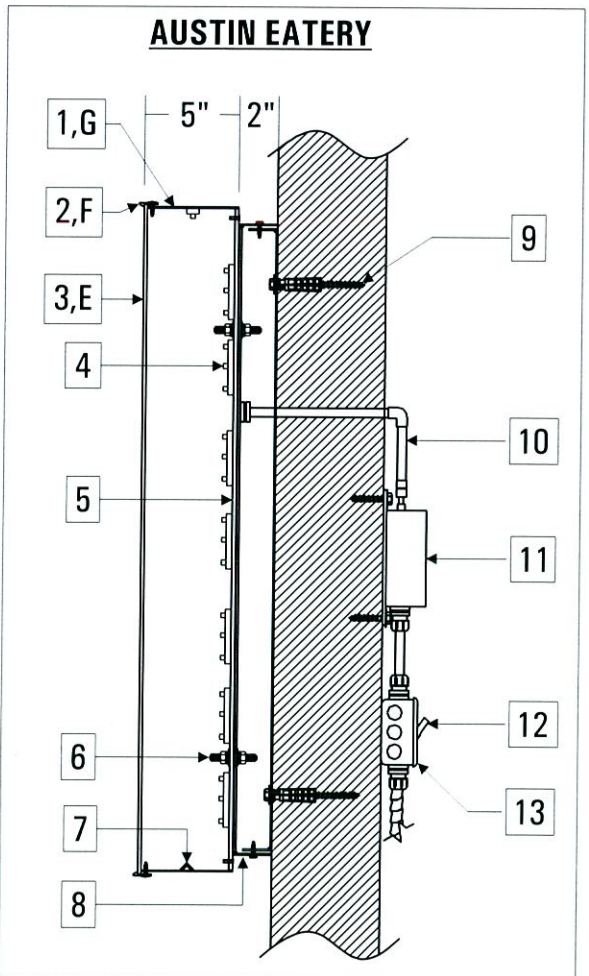
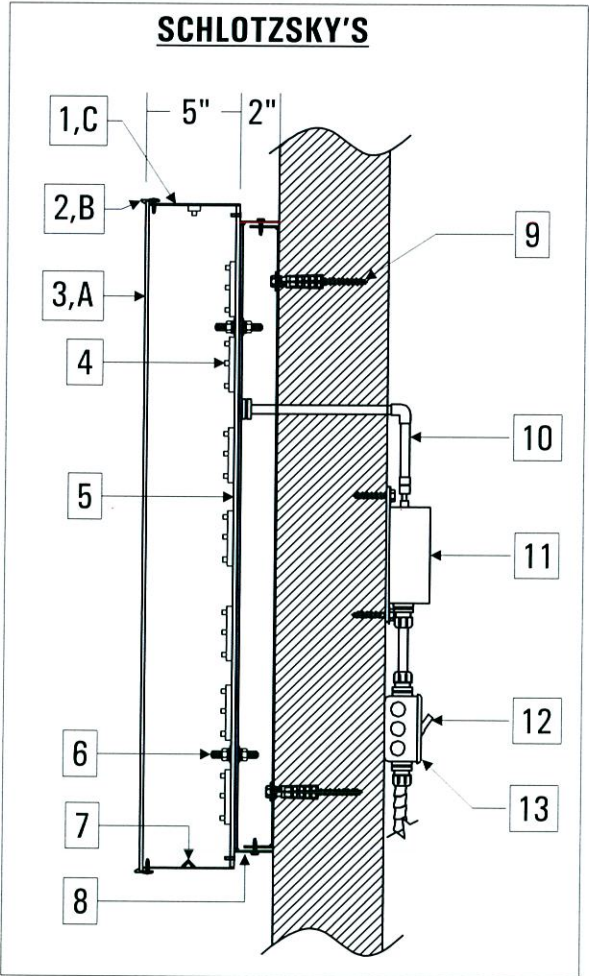

Materials	
1	.050 Aluminum Returns
2	1" Trimcap
3	3/16" Acrylic Face
4	White LED Strips Mounted to Back of CL
5	.090 Alum. Back
6	3/8" All-Thread
7	1/4" Weep Holes
8	2" Aluminum Wireway
9	Mounting Hardware (Depends of Building)
10	1/2" Flex Conduit
11	120 Volt Power Supply
12	Disconnect Switch
13	J-Box w/Prime Elec. Leads (Power by Others)

SCHLOTZSKY'S: Colors & Finishes	
A	White Acrylic Face
B	1" Black Trimcap
C	White Inside/Gloss Black Returns
D	.25" Routed "®" Painted Black

AUSTIN EATERY: Colors & Finishes	
E	3M 3630-84 Tangerine
F	1" Black Trimcap
G	Gloss Black Returns

Notes

- Wireway to be painted Silver

Rev 1:	
Rev 2:	
Rev 3:	
Rev 4:	
Rev 5:	



Designer: MEB	Date: 1-5-19
Client: Schlotzsky's Austin Eatery	
File Path: z/Rest/Schlotzskys/Specs/WWCL_HorzStacked_White	

- Proof Is Approved. Proceed With Production Of Order
- Proof Is Approved With Corrections. Make Corrections As Indicated And Proceed With Production Of Order

Signature: _____
 Print Name: _____
 Date: _____



These plans are the exclusive property of Design Team Sign Company and are the result of the original work of its employees. They are submitted to your company for the sole purpose of your consideration of whether to purchase these plans or to purchase from Design Team Sign Company a product manufactured according to these plans. Distribution or exhibition of the plans to anyone other than employees of your company, or use of these plans to construct a product similar to one embodied herein, is expressly forbidden. In the event that exhibition or construction occurs, Design Team Sign

For South Elevation



16"x 113.8" = 12.6
 12.8"x 84.4" = 7.5
 Actual Sq Ft = 20.1

Total Sq Ft: 35.3"x 113.8" = 27.9

Materials	
1	.050 Aluminum Returns
2	1" Trimcap
3	3/16" Acrylic Face
4	White LED Strips Mounted to Back of CL
5	.090 Alum. Back
6	3/8" All-Thread
7	1/4" Weep Holes
8	2" Aluminum Wireway
9	Mounting Hardware (Depends of Building)
10	1/2" Flex Conduit
11	120 Volt Power Supply
12	Disconnect Switch
13	J-Box w/Prime Elec. Leads (Power by Others)

SCHLOTZSKY'S: Colors & Finishes	
A	White Acrylic Face w/Black Perf
B	White Inside/Gloss Black Returns
C	1" Black Trimcap
D	.25" Routed "®" Painted Black

AUSTIN EATERY: Colors & Finishes	
E	3M 3630-84 Tangerine
F	1" Black Trimcap
G	Gloss Black Returns

Notes

- Wireways to be painted Silver

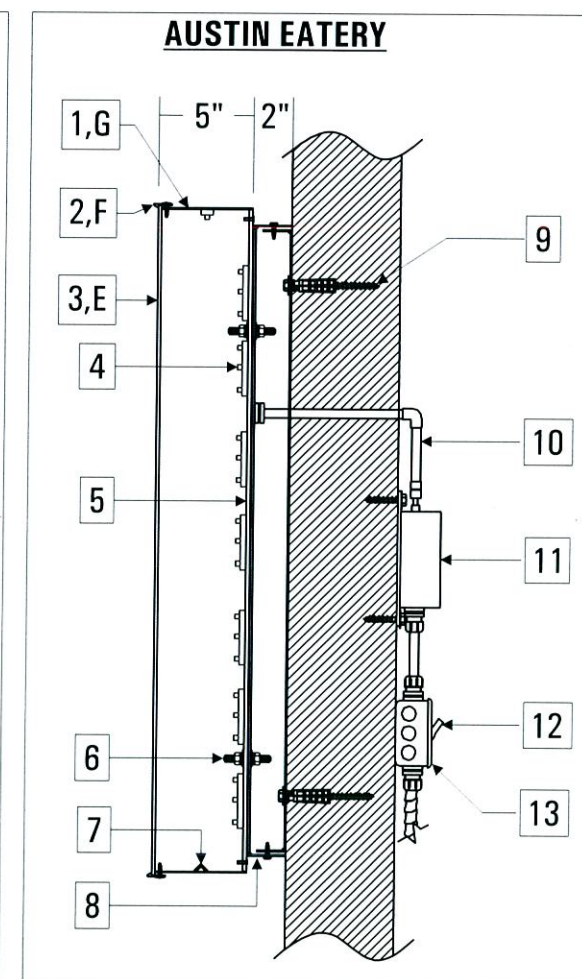
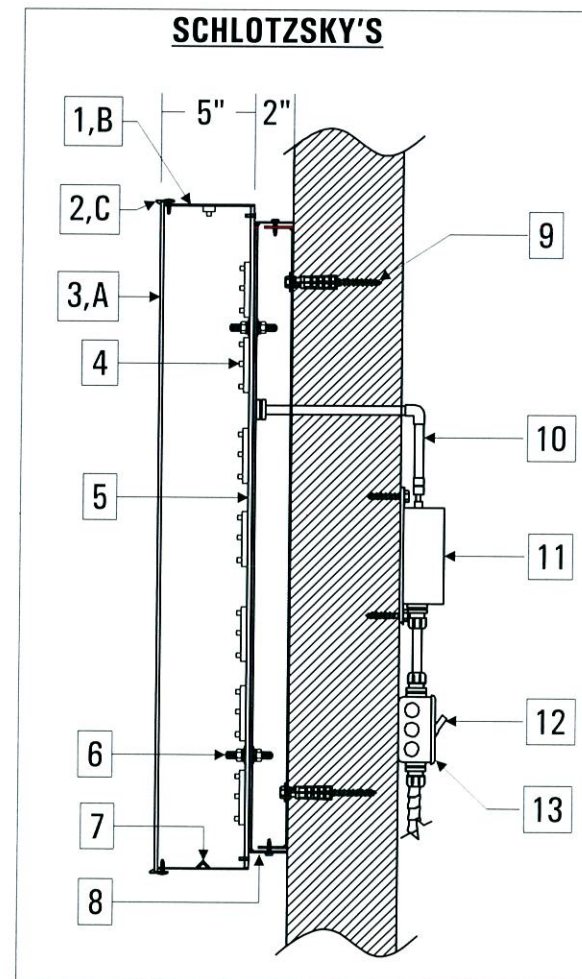

Rev 1:	
Rev 2:	
Rev 3:	
Rev 4:	
Rev 5:	

Designer: MEB	Date: 1-5-19
Client: Schlotzsky's Austin Eatery	
File Path: z/Rest/Schlotzskys/Specs/WWCL_HorzStacked_White	

- Proof Is Approved. Proceed With Production Of Order
- Proof Is Approved With Corrections. Make Corrections As Indicated And Proceed With Production Of Order

Signature: _____
 I have reviewed this proof in regard to: Sign type, order quantity, and accuracy of icons, symbols, and text (e.g. spelling capitalization, punctuation).
 Print Name: _____
 Date: _____



These plans are the exclusive property of Design Team Sign Company and are the result of the original work of its employees. They are submitted to your company for the sole purpose of your consideration of whether to purchase these plans or to purchase from Design Team Sign Company a product manufactured according to these plans. Distribution or exhibition of the plans to anyone other than employees of your company, or use or these plans to construct a product similar to one embodied herein, is expressly forbidden. In the event that exhibition or construction occurs, Design Team Sign



For North Elevation

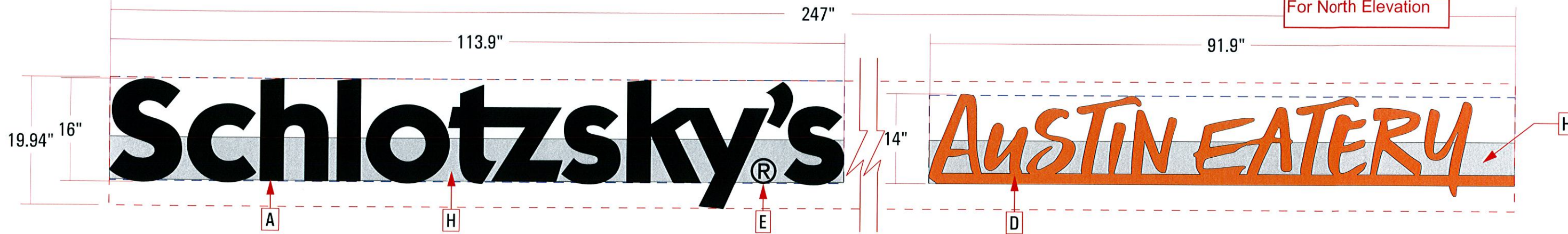

16"x 113.9" = 12.7
 14"x 91.9" = 8.9
Actual Sq Ft = 21.6
 19.94" x 247" = 34.203
Total Sq Ft = 34.203

Materials	
1	.050 Aluminum Returns
2	1" Trimcap
3	3/16" Acrylic Face
4	White LED Strips Mounted to Back of CL
5	.090 Alum. Back
6	3/8" All-Thread
7	1/4" Weep Holes
8	2" Aluminum Wireway
9	Mounting Hardware (Depends of Building)
10	1/2" Flex Conduit
11	120 Volt Power Supply
12	Disconnect Switch
13	J-Box w/Prime Elec. Leads (Power by Others)

SCHLOTZSKY'S: Colors & Finishes	
A	White Acrylic Face w/Black Perf
B	White Inside/Gloss Black Returns
C	1" Black Trimcap
D	.25" Routed "@" Painted Black

AUSTIN EATERY: Colors & Finishes	
E	White Acrylic w/3M 3630-84 Tangerine
F	Gloss Black Returns
G	1" Black Trimcap
H	Paint Silver - Raceway

Notes

- This product is site specific

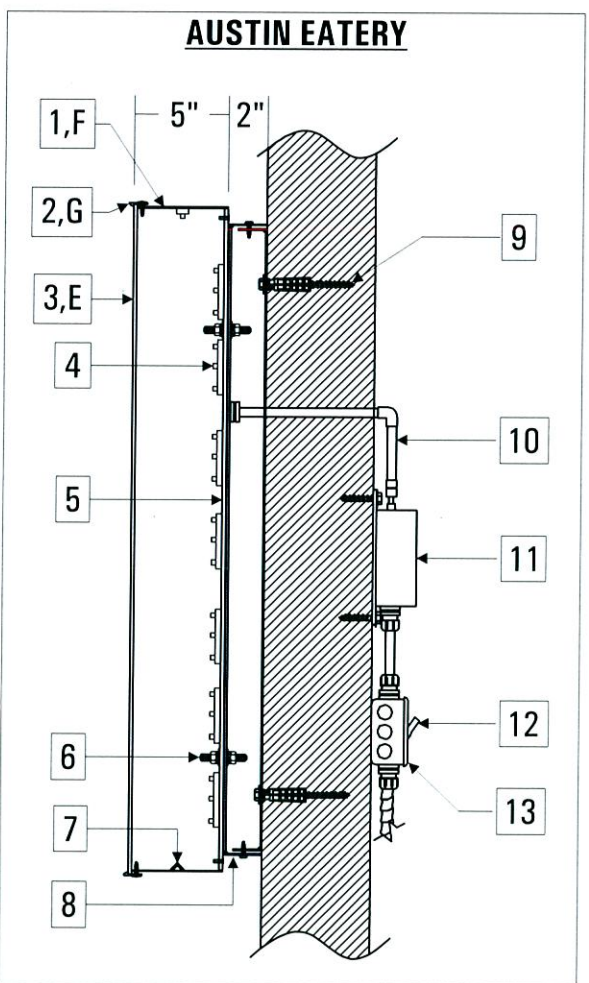
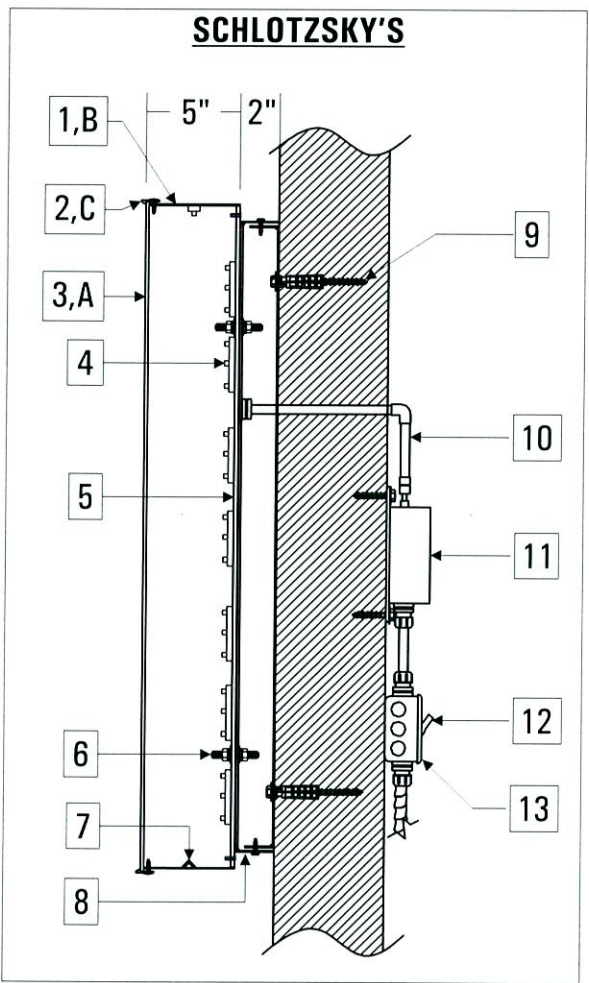

Rev 1: Added Total SQ FT - JAC - 3/29/19
Rev 2:
Rev 3:
Rev 4:
Rev 5:



Designer: MEB	Date: 2-6-19
Client: Schlotzsky's Austin Eatery	
File Path: z:\Rest\SAE\Specs\RWCL_Linear_Perf_SiteSpec	

- Proof Is Approved. Proceed With Production Of Order
- Proof Is Approved With Corrections. Make Corrections As Indicated And Proceed With Production Of Order

Signature: _____
 Print Name: _____
 Date: _____



These plans are the exclusive property of Design Team Sign Company and are the result of the original work of its employees. They are submitted to your company for the sole purpose of your consideration of whether to purchase these plans or to purchase from Design Team Sign Company a product manufactured according to these plans. Distribution or exhibition of the plans to anyone other than employees of your company, or use of these plans to construct a product similar to one embodied herein, is expressly forbidden. In the event that exhibition or construction occurs, Design Team Sign Company will be notified.

For North, South and West Elevations



Materials

1	.050 Aluminum Returns
2	1" Trimcap
3	3/16" Acrylic Face
4	LED Modules
5	Flex Conduit
6	.090 Aluminum Back
7	1/4" Weep Holes
8	120V Power Supply with On/Off switches
9	5" Lag & Shield

Colors & Finishes

A	Matte Black Returns / Trimcap
B	2447 Acrylic Face
C	Vinyl to Match PMS 3282 Turquoise 1st Surf.
D	Vinyl to Match PMS 2768 (AKZO Sign-3966)

Notes

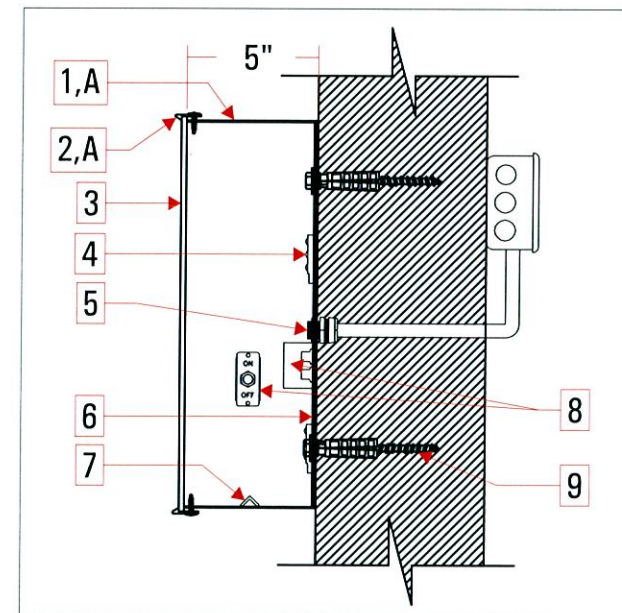

Rev 1:	
Rev 2:	
Rev 3:	
Rev 4:	
Rev 5:	

Designer: MEB	Date: 2-5-19
Client: Schlotzsky's Cinnabon	
File Path: z/Restaurant/Schlotzskys/Specs/CinnabonWallCabinet	

- Proof Is Approved. Proceed With Production Of Order
- Proof Is Approved With Corrections. Make Corrections As Indicated And Proceed With Production Of Order

Signature: _____
I have reviewed this proof in regard to: Sign type, order quantity, and accuracy of icons, symbols, and text (e.g. spelling capitalization, punctuation).
 Print Name: _____
 Date: _____



These plans are the exclusive property of Design Team Sign Company and are the result of the original work of its employees. They are submitted to your company for the sole purpose of your consideration of whether to purchase these plans or to purchase from Design Team Sign Company a product manufactured according to these plans. Distribution or exhibition of the plans to anyone other than employees of your company, or use or these plans to construct a product similar to one embodied herein, is expressly forbidden. In the event that exhibition or construction occurs, Design Team Sign Company agrees to be reimbursed \$500 in compensation for



F Ready-To-Apply Vinyl

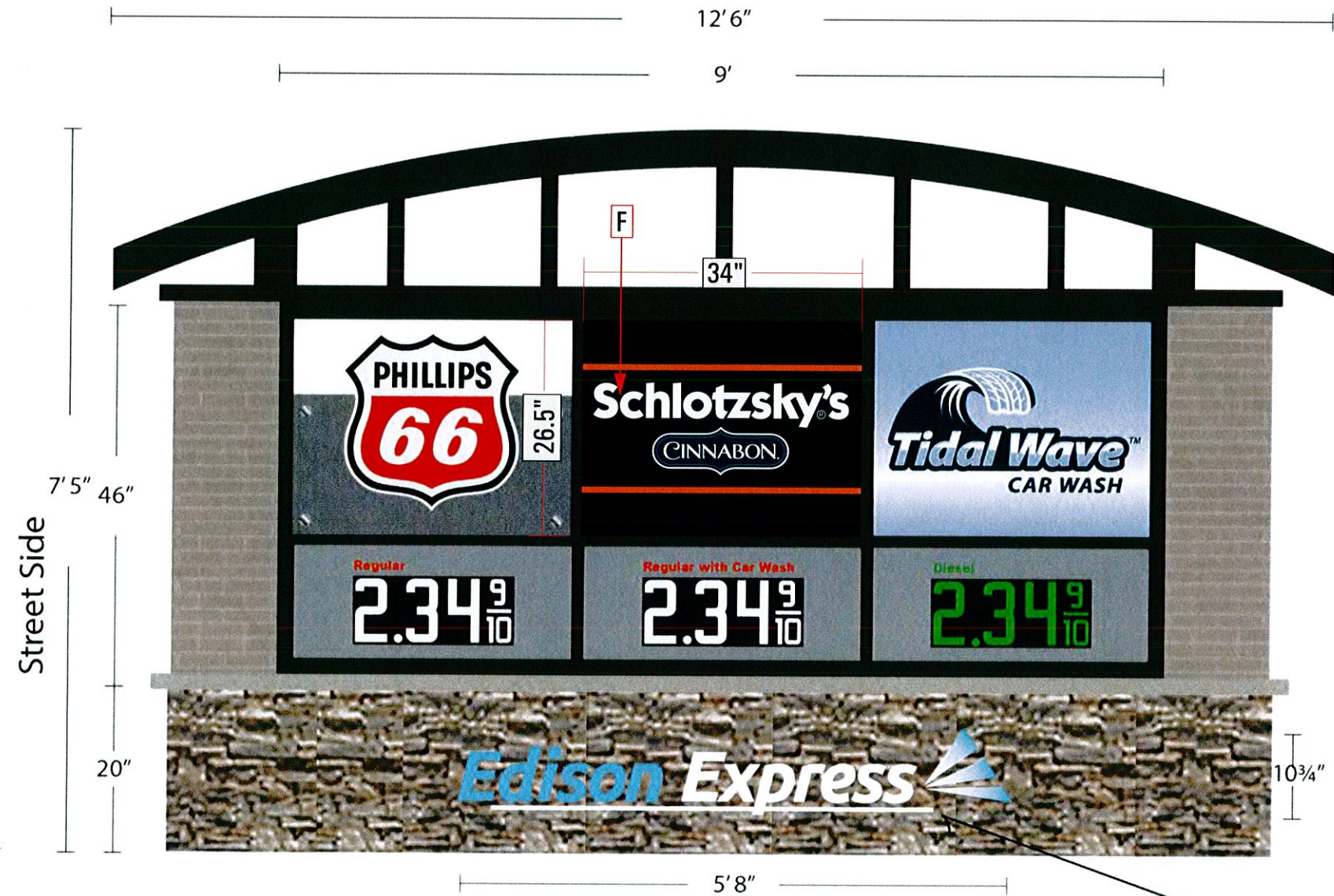

Two-sided
Illuminated
Monument Tenant Sign

- Extruded aluminum roof construction
- LED internal illumination
- Flat acrylic faces with vinyl graphics
- LED Gas price signs
- Non-illuminated flat cut acrylic letters
- Brick & Stone base
- UL Listed with lockable disconnect switch

Rev 1: CM 2-14-19 Updated Logo on Monument
Rev 2:
Rev 3:
Rev 4:
Rev 5:



Designer: MEB	Date: 2-5-19	Option #1 - MEB
Client: Schlotzsky's - 158 Long Rd		
File Path: z/Restaurant/Schlotzskys/ChesterfieldMO/CP		

- Proof Is Approved. Proceed With Production Of Order
- Proof Is Approved With Corrections. Make Corrections As Indicated And Proceed With Production Of Order

Signature: _____
I have reviewed this proof in regard to: Sign type, order quantity, and accuracy of icons, symbols, and text (e.g. spelling capitalization, punctuation).
 Print Name: _____
 Date: _____



These plans are the exclusive property of Design Team Sign Company and are the result of the original work of its employees. They are submitted to your company for the sole purpose of your consideration of whether to purchase these plans or to purchase from Design Team Sign Company a product manufactured according to these plans. Distribution or exhibition of the plans to anyone other than employees of your company, or use of these plans to construct a product similar to one embodied herein, is expressly forbidden. In the event that exhibition or construction occurs, Design Team Sign Company shall be notified immediately.

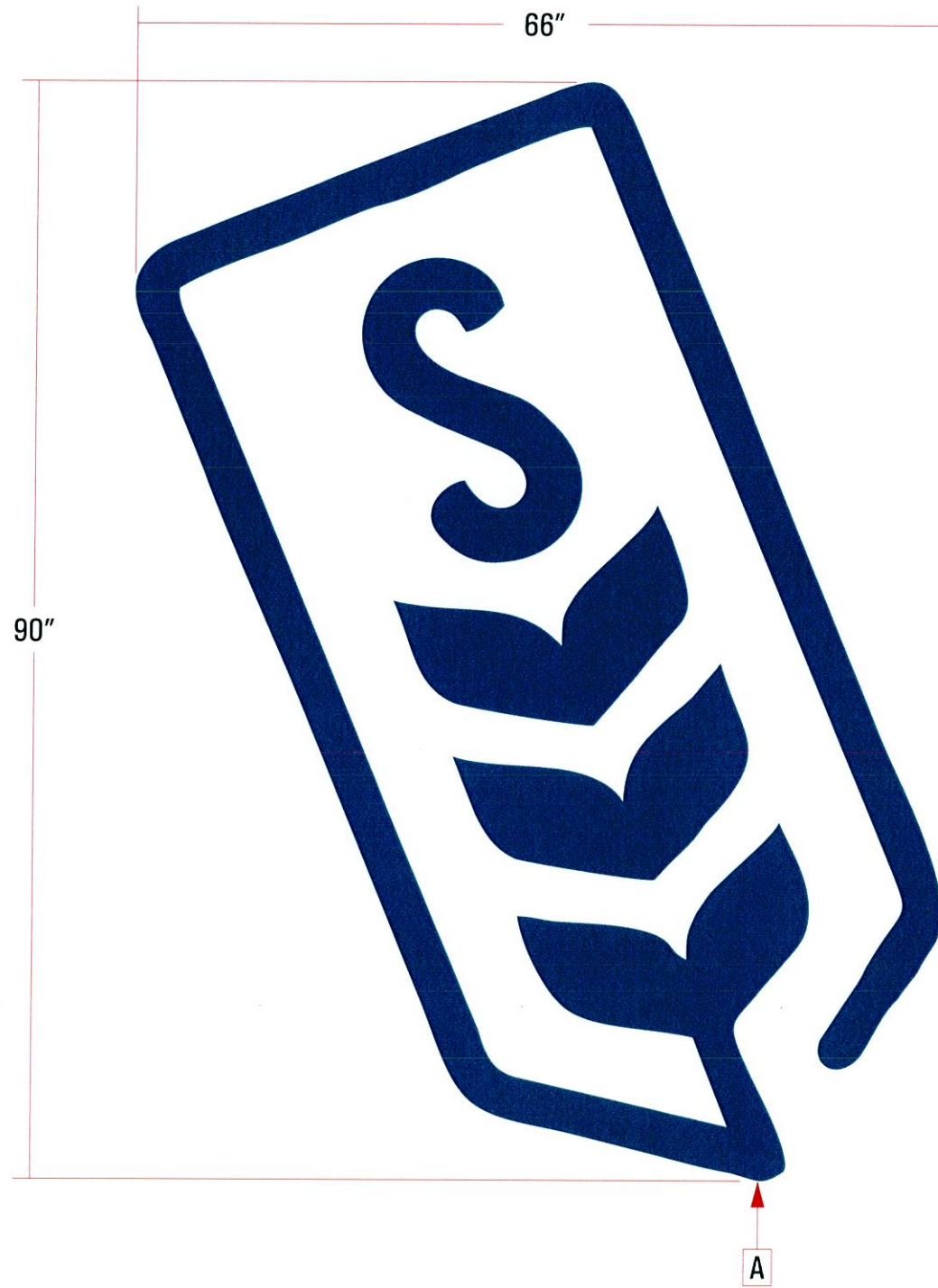

90" x 66" = 41.25 SQ FT

Colors & Finishes

A Painted Color TBD

Rev 1:

Rev 2:

Rev 3:

Rev 4:

Rev 5:

Notes

Designer: MEB	Date: 2-8-19
Client: Schlotzsky's	
File Path: z/Restaurant/Schlotzskys/CorpSpecs	

- Proof Is Approved. Proceed With Production Of Order
- Proof Is Approved With Corrections. Make Corrections As Indicated And Proceed With Production Of Order

Signature: _____
I have reviewed this proof in regard to: Sign type; order quantity; and accuracy of icons, symbols, and text (e.g. spelling capitalization, punctuation).
 Print Name: _____
 Date: _____



These plans are the exclusive property of Design Team Sign Company and are the result of the original work of its employees. They are submitted to your company for the sole purpose of your consideration of whether to purchase these plans or to purchase from Design Team Sign Company a product manufactured according to these plans. Distribution or exhibition of the plans to anyone other than employees of your company, or use or these plans to construct a product similar to one embodied herein, is expressly forbidden. In the event that exhibition or construction occurs, Design Team Sign Company agrees to be reimbursed \$500 in consideration for

For West Elevation

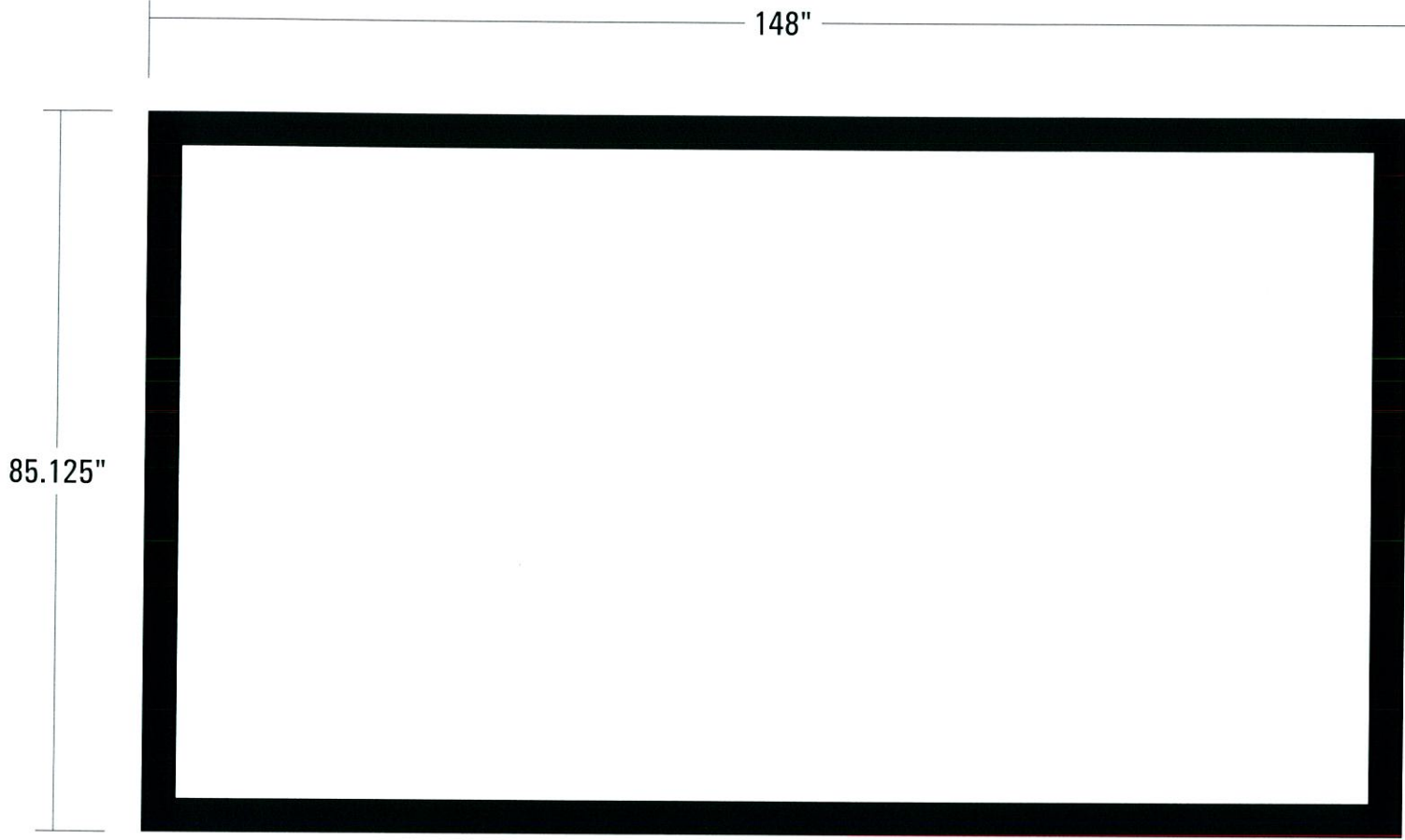

85.125" x 148" = 87.5 SQ FT

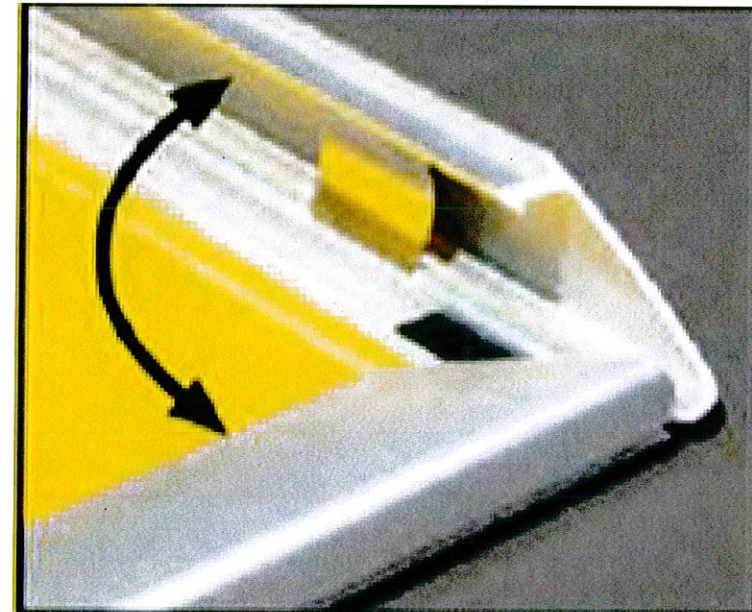

Colors & Finishes

A Black Flip Frame

Rev #1 -
Rev #2 -
Rev #3 -
Rev #4 -
Rev #5 -
Rev #6 -

Notes

Blank area for notes.



Designer: JAC	Date: 3/28/19
Client: Schlotzky's	
File Path: Z/Restaurant/Schlotzkys/CorpSpec	

- Proof Is Approved. Proceed With Production Of Order
- Proof Is Approved With Corrections. Make Corrections As Indicated And Proceed With Production Of Order

Signature: _____
I have reviewed this proof in regard to: Sign type, order quantity, and accuracy of icons, symbols, and text (e.g. spelling capitalization, punctuation).
 Print Name: _____
 Date: _____



These plans are the exclusive property of Design Team Sign Company and are the result of the original work of its employees. They are submitted to your company for the sole purpose of your consideration of whether to purchase these plans or to purchase from Design Team Sign Company a product manufactured according to these plans. Distribution or exhibition of the plans to anyone other than employees of your company, or use of these plans to construct a product similar to one embodied herein, is expressly forbidden. In the event that exhibition or construction occurs, Design Team Sign



68.5" x 288" = 137 SQ. FT

Colors & Finishes

A Painted Color TBD

Rev 1:

Rev 2:

Rev 3:

Rev 4:

Rev 5:

Notes

Sizes approximate. Mural by others.

Designer: JAC	Date: 3/28/19
Client: Schlotzsky's	
File Path: z/Restaurant/Schlotzskys/CorpSpecs	

- Proof Is Approved. Proceed With Production Of Order
- Proof Is Approved With Corrections. Make Corrections As Indicated And Proceed With Production Of Order

Signature: _____
I have reviewed this proof in regard to: Sign type, order quantity, and accuracy of icons, symbols, and text (e.g. spelling capitalization, punctuation).
 Print Name: _____
 Date: _____